

User's Manual

Tuxon-MC

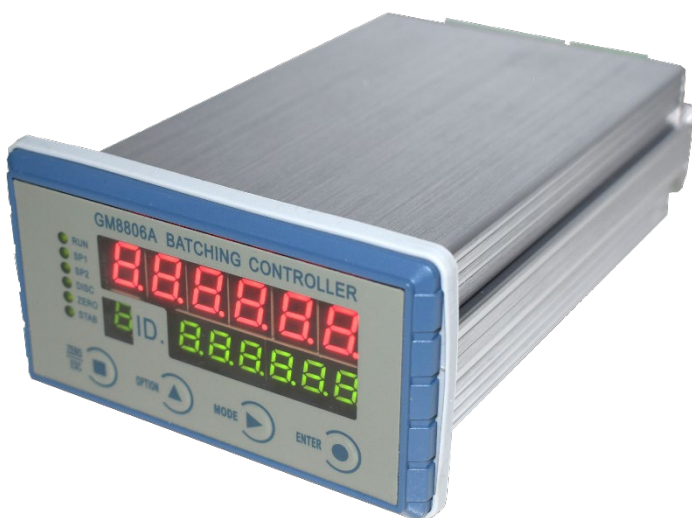

Ver. 2 / 2022 / 01

Table

1.General Information	- 1 -
1.1 Function	- 1 -
1.2 Description.....	- 2 -
1.3 Rear illustration.....	- 3 -
1.4 Specification	- 4 -
1.5 Dimension.....	- 5 -
2. Wiring	- 5 -
2.1 Installation.....	- 6 -
2.2 Power connection	- 7 -
2.3 Load cell connection.....	- 7 -
2.4 I/O terminals	- 9 -
2.5 Analog output connection	- 10 -
2.6 Serial port connection.....	- 11 -
3. Calibration.....	- 12 -
3.1 Illumination.....	- 12 -
3.2 Calibration flow chart.....	- 12 -
3.3 Millivolt display.....	- 15 -
3.4 Calibration without weights.....	- 16 -
3.5 Quick zero/gain calibration	- 18 -
3.6 Parameter table	- 18 -
3.7 Parameter record.....	- 18 -
4. Parameter setting.....	- 19 -
4.1 Defination.....	- 19 -
4.2 Operation parameter table.....	- 21 -
5. Operation	- 24 -
5.1 Operating status	- 24 -
5.2 Operating procedure.....	- 24 -

5.3 Manual zeroing	- 24 -
5.4 I/O testing	- 25 -
5.5 I/O defination	- 26 -
5.6 Display testing	- 28 -
5.7 Reset	- 29 -
5.8 Backup.....	- 30 -
5.9 Restore backup	- 30 -
5.10 Analog calibration	- 30 -
5.11 Password	- 32 -
5.12 Password setting	- 32 -
5.13 Operation mode.....	- 33 -
6. Serial port communication	- 33 -
6.1 RS protocol	- 34 -
6.2 RE protocol.....	- 43 -
6.3 MODBUS protocol	- 45 -
7. Error and alarm message	- 55 -

1 General information

Tuxon-MC weighing indicator is a small-volume display specially for weighing and controlling in industrial field, which features are abundant communication, high precision, strong function and easy operation etc., thus to be widely used in weighing and controlling equipment, such as concrete mixer, asphalt batching, feeding stuff, metallurgy converter and so on.

1.1 Function:



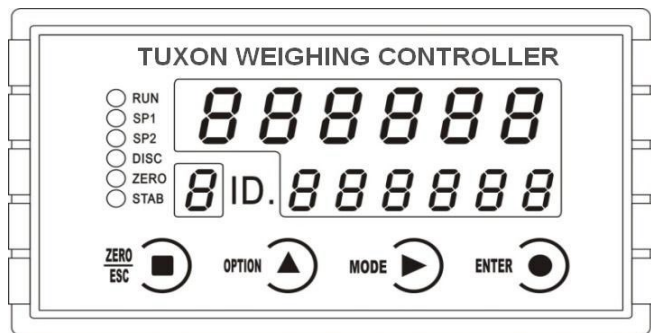

- ✎ Small volume, unique design, easy operation;
- ✎ Suit to all of load cells at bridge-type resistance strain gauge;
- ✎ Multi digital filter;
- ✎ 5set points are used widely to meet more requirement;
- ✎ **RS232/RS485** to ensure stable communication;
- ✎ Abundant communication protocols(**RS/RE/MODBUS** optional) to communicate easier with host computer;
- ✎ High precision 16bit DA analog output;
- ✎ Digital calibration with or without weights;
- ✎ Password protection for calibration, operation parameters etc.;
- ✎ Automatic zeroing when power up;
- ✎ Automatic zero tracking.
- ✎ Three operation modes(optional).

1.2 Description



P 1-1

Keypad:

-  Display value when zeroing or exit present function.
- : Parameters are optional.
- : Set parameter mode.
- : Enter parameters or calibration or confirmation.

Status indication:

- RUN : Not define
- SP1/ SP2 : Not define
- DISC : Not define
- ZERO: Zero indication light if the weight is among **0±1/4d**.
- STAB: Stability indication light if the weight is in stable range.

Display:

Main display: 6digits, display weight and parameters.

Sub-display: 6digits, display analog, set point and

Set point display: 1 digit, display set point numbers.

1.3 Rear illustration

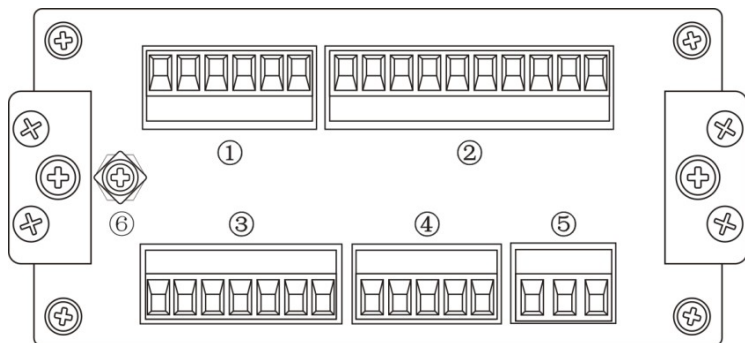

P 1-2

- ① I/O input terminals
- ② I/O output terminals
- ③ Load cell terminals
- ④ Serial port / analog terminals
- ⑤ Power connection
- ⑥ Fuse socket

1.4 Specification

Common:

Power supply: **AC90V~260V 50Hz (or 60Hz) \pm 2%**

Filter: **Inside**

Working temperature: **-10~40°C**

Max humidity: **90%R.H without dew**

Power consumption: **About 10W**

Dimension: **105×151×57mm**

Analog:

Load cell power: **DC5V 300mA (Max)**

Input impedance: **10M Ω**

Zero steady range: **0.02~9mV**

Input sensitivity: **0.01uV/d**

Gain input range: **0.2~10mV**

Transfer mode: **Sigma - Delta**

A/D conversion speed: **120times/sec**

Non-linearity: **0.01%F.S**

Gain drift: **10PPM/°C**

Display Precision: **1/30000**

Digital:

Weight display: **6digits red high-brightness LED**

Minus display: **"-"**

Overload display: **"OFL"**

Decimal point: **5kinds (optional)**

1.5 Dimension

Front Panel

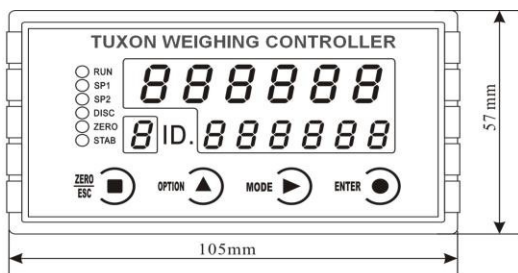

Rear Panel

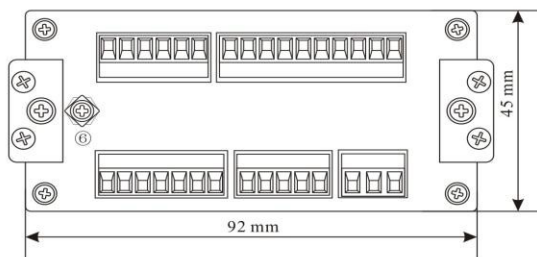

Side View

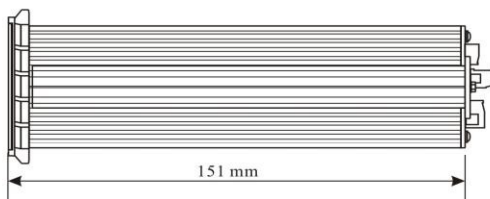

Rear Size

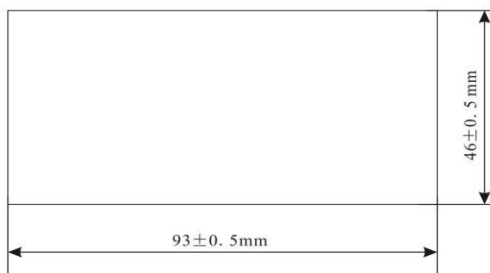

2 Wiring

2.1 Installation

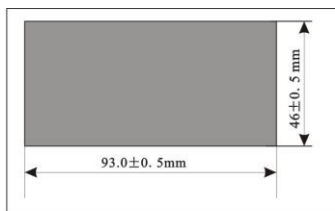

1. Cut hole as left size in the suitable place of control box.

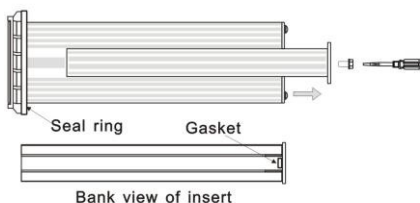

2. Screw open in four corners, then dismantle mounting plates.

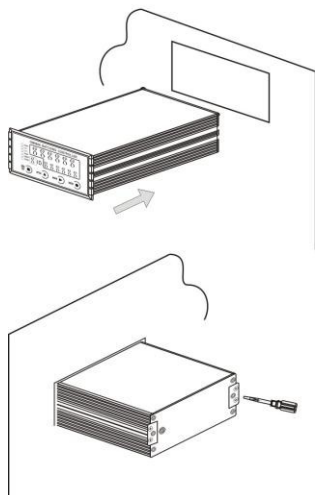

3. Install indicator in the front of control box.

4. Insert mounting plates on both sides and then screw tightly.

2.2 Power connection

Tuxon-MC weighing indicator connects power as follows:



P 2-2



1. AC power must connect with ground;
2. Please do not connect indicator's earth line with other huge electronic equipment directly.

2.3 Load cell connection

EX+: Excitation+ **EX-**: Excitation- **SN+**: Sense+ **SN-**: Sense- **SIG+**: Signal+ **SIG-**: Signal-

6 wires	EX+	SN+	EX-	SN-	SIG+	SIG-	Shield
4-wires	EX+		EX-		SIG+	SIG-	Shield

1) 6 wires connection:

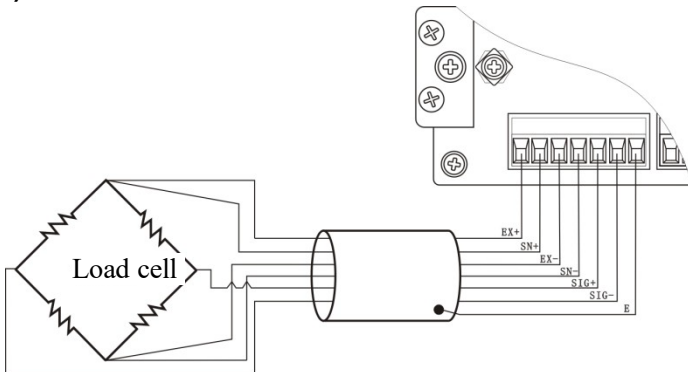

2) 4 wires connection

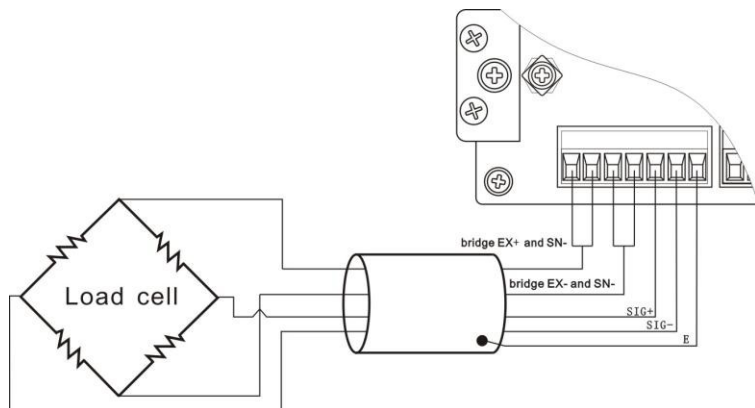

P 2-4



1. As load cell output sensitive analog signal, please use shield cable to separate with other cables, especially AC power;
2. 4 wires connection is suitable for short distance and stable temperature or low precision field, otherwise use 6 wires connection.
3. For more load cells parallel connection, their sensitivity (**mV/V**) should be same.

2.4 I/O terminals

Tuxon-MC Weighing indicator transfer data by optoelectronic isolation technology, thus need 24 V DC outside as power supply, which anode connect with indicator 24 V+, and cathode with 24V- through the COM1 (DC+) and the COM2 (DC-). The input signal is low level effective, and the output is transistor open-collector output, which driving current can reach 500m A.

I/O definition as follows:

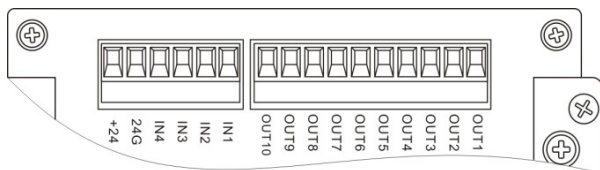

P 2-5

Indicator input terminal connection:

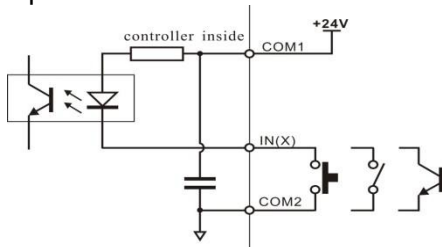

P 2-6

Indicator output terminal connection:

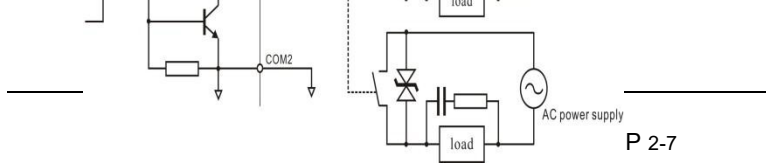

P 2-7

I/O tolerant definition as follows:

Output		Input	
OUT1	SP1	IN1	Zero
OUT2	SP2	IN2	NC
OUT3	SP3	IN3	NC
OUT4	SP4	IN4	NC
OUT5	SP5		
OUT6	SP6		
OUT7	Stable		
OUT8	Zero		
OUT9	Overflow		
OUT10	NC		

2.5 Analog output connection

Analog output two kinds: voltage and electric current. For voltage output, 0-5V/0-10V/-5-5V/-10-10V is optional for voltage output ; 4-20mA/0-20mA/0-24mA is optional for electric current output. Define terminals as follows:

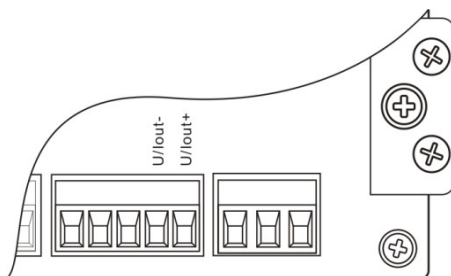

P 2-8

Note : Analog output is optional function, please

2.6 Serial port connection

Serial port(RS485 or RS232) connection as follows:

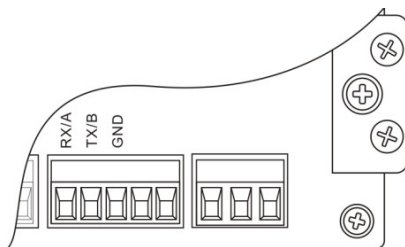

P 2-9

RS232 connection:

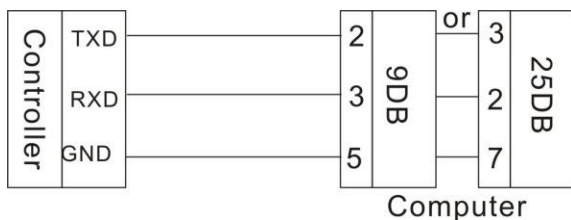

P 2-10

RS485 connection:

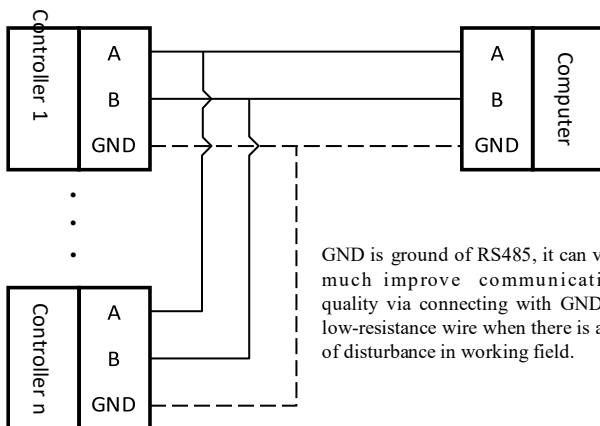



GND is ground of RS485, it can very much improve communication quality via connecting with GND by low-resistance wire when there is a lot of disturbance in working field.

P 2-11

3 Calibration



3.1 Instruction

Tuxon-MC Weighing indicator need calibrate at beginning of operation or changing any parts on weighing system or non-suitable application for user. The calibration can define radix point, minimum scale division, maximum scale capacity, zero and gain, etc.

User can press **MODE**  to enter next or press **ENTER**  to save setting to only change one parameter, and then press **EXIT**  to exit.

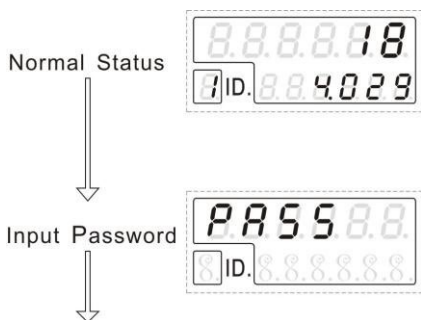
3.2 Flow chart



Press **MODE**  to display **CAL**, and then press **ENTER**  to enter password.

Input correct password, when display “**CAL ON**” one second, then enter to set radix point automatically.

The Position of
Decimal Point

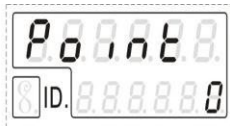

- 1) Press ^{OPTION}▲ set radix point (0~0.0000 5 kinds optional), press ^{ENTER}● to save and enter mini division.
- 2) If not change radix point, press ^{ENTER}● directly to enter mini division.

Min. Division



- 1) Press ^{OPTION}▲ to set mini division(1~50 6kinds optional), press ^{ENTER}● to save and enter max. capacity.
- 2) If not change mini division, press ^{ENTER}● directly to enter max. capacity.

Max. Capacity



- 1) Input max. capacity(\leq mini division \times 30000), press ^{ENTER}● to save and enter millivolt display.
- 2) If not change, press ^{ENTER}● to enter millivolt display directly.

Sensitivity of
load cell



- 1) Select suitable sensitivity based on load cell, press ^{ENTER}● to save and enter millivolt display. Otherwise to press ^{ENTER}● directly to enter millivolt display.

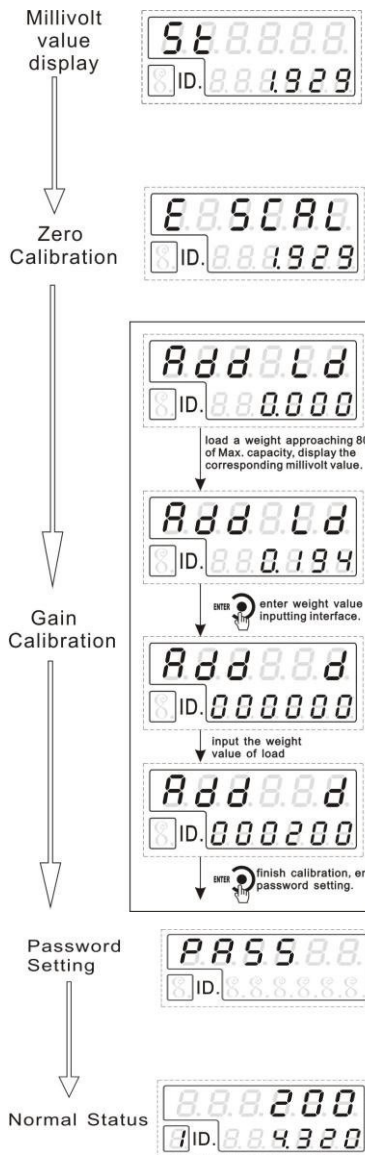

- 1) When load cell output millivolt value, press **ENTER** to enter zero calibration directly.
- 2) The display value is similar with millivolt from SIG+/SIG- terminals. See Character 3.3 for details.

- 1) When scale platform is stable, press **ENTER** to take present weight as zero, and enter gain calibration.
- 2) Press **ZERO/ESC** to reserve original zero and enter gain calibration.

1) Gain calibration as the left chart.

▲ When calibration with weights, please record zero millivolt, gain millivolt and weight value in list. If no weights, user will calibrate according to these data.

2) Press **ZERO/ESC** to enter password directly, no gain calibration.

- 1) See Character 5.11 to set password, then press **ZERO/ESC** to exit calibration and return.
- 2) If not set password, press **ZERO/ESC** directly to return. Normal working status.

3.3 Millivolt display

This function is mainly used to test weighing system, four-corner position-error of force-transmitted equipment and load cell's linearity.

1. Test weighing system

(1) If the indicator display variational millivolt value according to add weight, thus indicate load cells are connected correctly and force-transmitted equipment is operated normally.

(2) If the indicator display OFL (or -OFL), thus indicate the weight is too heavy (or too light), then need unload (or add) the weight. But if always display OFL (or -OFL) after changing weight, maybe the following reason cause:

- a. Please check force-transmitted equipment.
- b. Please check the load cell's connection.
- c. Please check Load cells.

2. Test four-corner position-error of force-transmitted equipment

Please load same weight on scale's every corner and record individual millivolt value. If the values are obviously different, please adjust force-transmitted equipment.

3. Test load cell's linearity

Please load several same weight values within the weighing capacity and record relevant millivolt value after zeroing every time; if the discrepancy is bigger among millivolt values, thus indicate that the load cell's linearity is not good, need change new load cell or adjust force-transmitted equipment.

3.4 Calibration without weights

Calibration without weights is only for urgency. If change new load cells or indicator, or adjust weighing system, calibration without weights is not correct.

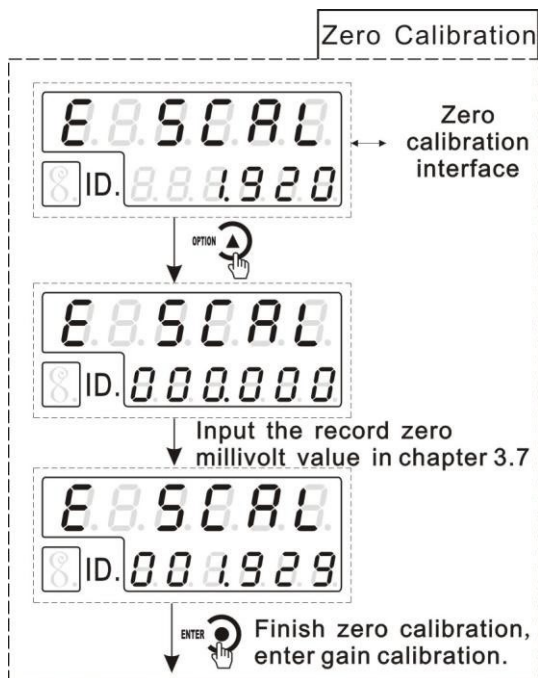

Gain Calibration

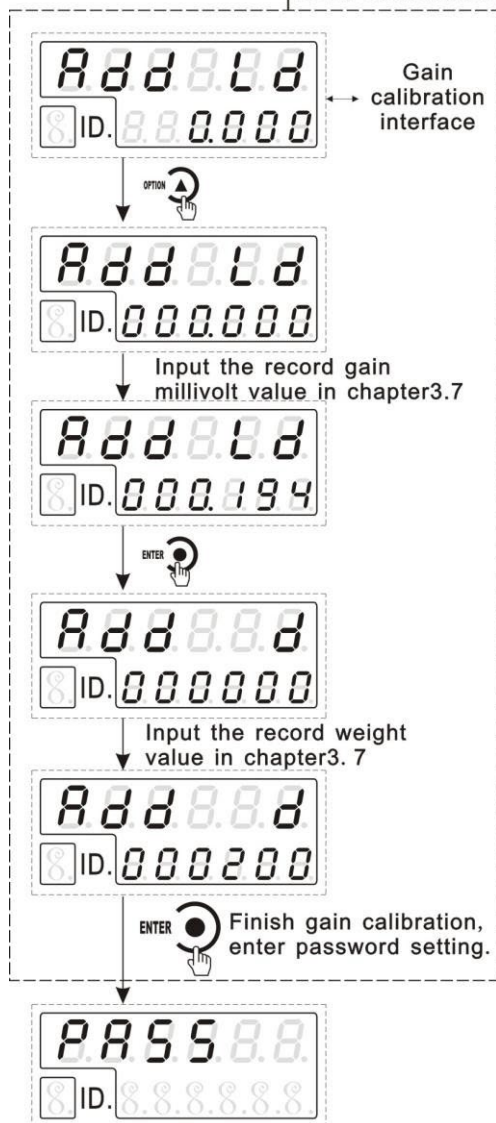

3.5 Fast zero / gain calibration

In weighing status, press  for long time, when display password input, then input password correctly and enter zero calibration. See Character 5.10 for details.

3.6 Calibration parameter table

Sign	Parameter	Type	Division	Initial value
Point	Decimal point	5	0,0.0,0.00,0.000,0.0000	0
1d=	Mini division	6	1,2,5,10,20,50	1
CP	Max capacity		≤mini division×30000	10000
St	System millivolt			
SE	Sensitivity	2	2, 3	2(mV/V)
E SCAL	Zero			
AddLd(d)	Gain			
PASS	Set password			000000

3.7 Calibration parameter record

Parameter	Valued	Date	Remark
Decimal point position			
Mini division			
Max capacity			
Load cell sensitivity			
Password setting			

List(calibration with weights):

Times	Zero millivolt (mV)	Gain millivolt (mV)	Weights (Kg)	Date	Remark
1					
2					
3					

4 Parameter setting

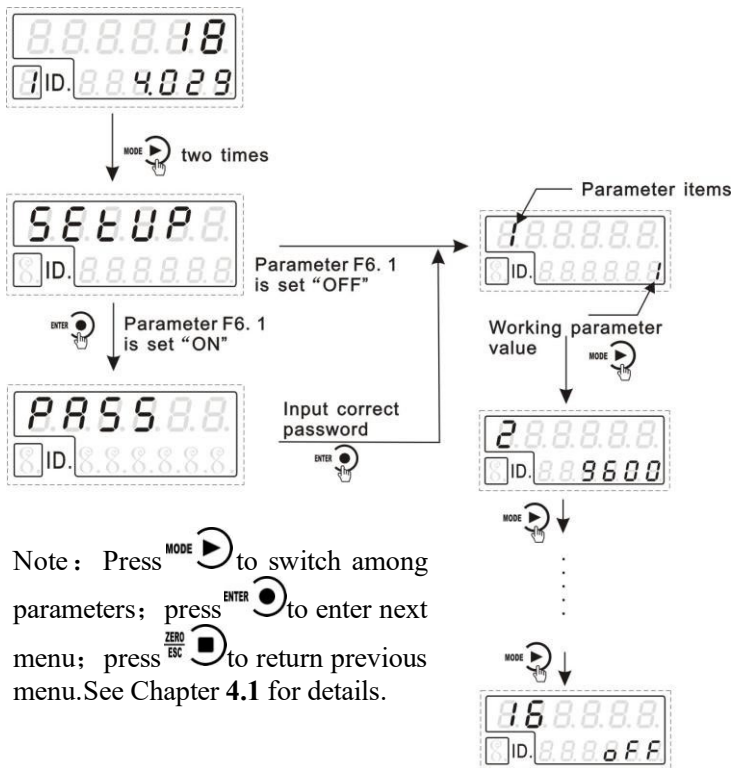

Note: Press to switch among parameters; press to enter next menu; press to return previous menu. See Chapter 4.1 for details.

4.1 Definition

Press to select parameters, then press and to set parameters, after that, press to save setting.

1) Optional parameter setting

Set "parameter F1.1" (ON) for example:



1. Press **ENTER** (●), then sub-display sparkle “OFF”.



2. Press **OPTION** (▲), then sub-display show “ON”.



3. Press **ENTER** (●) to save setting. If not need set other parameters, press **ZERO/ESC** (■) to return.

2) Numerical parameter setting

Set “parameter **F1.3**” (as **39**) for example:



1. Press **ENTER** (●), sub-display sparkle “0” in the right.



2. Press **OPTION** (▲) till sub-display show “3”, then press **MODE** (▶), sparkle move to the right one.



3. Press **OPTION** (▲) till sub-display show “9”, then press **ENTER** (●) to save and finish.



4.2 Operation parameter table

No.	Para.	Initial	Description	
F1	None	None	No.1 parameter	
F1.1	ON/OFF F	OFF	Automatic zeroing when power on	
F1.2	00~99	01	Zero tacking range(00 ~ 99d optional). If setting 0, not zero tracking.	
F1.3	00~99	05	Zeroing range(01% ~ 99% of full capacity).	
F1.4	00~99	01	Stability criterion range(01 ~ 99d optional). If 0, always stability and the light are on.	
F1.5	0~9	4	Digital filter parameter 0 : no filter; 9 : strongest filter	
F1.6	0~9	7	Stability filter 0 : no filter; 9 : strongest filter	
F2	None	None	No.2 parameter	
F2.1	xxxxxx	0	Set point 1 (max. weight value)	Set point 1 to 5 according to weight value from max. to mini. Set weight value as need, if no use, keep 0. Note: Do not set 0 as weight value between set points.
F2.2	xxxxxx	0	Set point 2	
F2.3	xxxxxx	0	Set point 3	
F2.4	xxxxxx	0	Set point 4	
F2.5	xxxxxx	0	Set point 5 (mini weight value)	
F3	None	None	No.3 parameter	
F3.1	4-20 / 0-20 / 0-24 /	4-20	Analog output: 4-20: 4-20mA 0-20: 0-20mA	

	0-5 / 0-10 / -5-5 / -10-10		0-24: 0-24mA 0-5 : 0-5V 0-10: 0-10V -5-5 : -5-5V -10-10 : -10-10V
F3.2	ON / OFF	OFF	Analog output mode: OFF : Weight and analog output are direct proportion; ON : Weight and analog output are inverse proportion.
F4	None	None	No.4 parameter
F4.1	00~99	01	Scale no.
F4.2	1200~ 57600	9600	Baud rate
F4.3	RS/RE/ Bus	RS	RS: GM; RE: CHIMEI; Bus: MODBUS.
F4.4	READ/ CONT	CONT	Communication mode: (Available when F4.3 is RS/RE) READ : command; CONT : continue
F4.4.1	0~5	1	Serial port data-sent speed(Available when F4.4 is CONT): 1-5 means 10-50ms; 0 means one character time.
F4.4	Rtu/Asc	Rtu	MODBUS communication mode (Available when F4.3 is Bus)
F4.4.1	Hi Lo/Lo Hi	Hi Lo	MODBUS dual-byte register storage turn(Available when F4.4 is Rtu): Hi Lo : High byte in the front, low byte at back ; Lo Hi : Low byte in the front, high byte at back.

F4.5	7-E-1/ 7-O-1/ 7-N-2/ 8-E-1/ 8-O-1/ 8-N-1/ 8-N-2	8-E-1	Data format(data bit + parity bit + stop bit), only the last 4 format is for MODBUS.
F5	None	None	No.5 parameter
F5.1	ON/OFF	OFF	OFF : Not need stability to adjudge whether output or not from set point; ON : Need stability to adjudge whether output or not from set point.
F5.2	DA/SP	DA	DA: Sub-display show analog value; SP: Sub-display show present weight among different set points. If present weight<mini set point, sub-display show weight value at mini set point; if present weight>set point 1, sub-display show weight value at set point 1; others sub-display show nearest set point-present weight.
F6	None	None	No.6 parameter
F6.1	ON / OFF	OFF	Password switch
F6.2			Password setting. See Character 5.11 for details.

5 Operation

5.1 Operation status

1. When power on, buzzer hoot, main and sub-display flash “8”, and instruction lights also sparkle.

2. After finished, main display show “8806.8A”, and sub-display show “software no. ”.



3. After 3 seconds, main display show present weight value, and sub-display show related setting in Character **F5.2**. See Character **F5.2** for details.



5.2 Working instrument



For examples: **F2.1=SP1**、**F2.2=SP2**、**F2.3=SP3**、**F2.4=SP4**、**F2.5=SP5**， present weight **W** compare with **SPx** to control I/O output.

Weight	Set point display	I/O output
W >= SP1	1	SP1 output effectively
SP2 <= W < SP1	2	SP2 output effectively
SP3 <= W < SP2	3	SP3 output effectively
SP4 <= W < SP3	4	SP4 output effectively
SP5 <= W < SP4	5	SP5 output effectively
W < SP5	6	SP6 output effectively

5.3 Manual zeroing

When stop, press  or input “zeroing” signal to clear gross weight value. Note: Operation must be in stable status or gross weight is in the zeroing range. Otherwise the indicator will display ERROR3 or ERROR2.

5.4 I/O testing

Press **MODE**  to switch among **OUT1~OUT10** and press **ZERO ESC**  to return. Please refer following flow chart:



← Stop

Press **MODE**  5 times till main-display show "tStio".



Press **ENTER** , main-display show "inPUt"



Press **ENTER**  to enter I/O input testing.

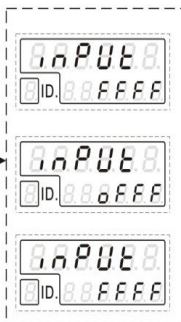

Sub-display indicate **F** means **IN1~IN4** from left to right, when input effectively, **F** change to **0**.

For example, **F** change to **0** indicates **IN1** input effectively and connect correctly.

Press **MODE** , main-display show "outPUt"



Press **ENTER**  to enter I/O output testing.

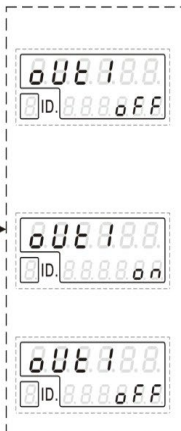



OUTPUT means testing. Main-display show output number, sub-display show status.

Press **OPTION** , sub-display **OFF** change to **ON** indicates **OUT1** output effectively and connect correctly.

Press **MODE**  to switch output numbers, such as from **OUT1** to **OUT2**.

5.5 I/O definition



When stop, user can define I/O ports by  and  to return.

The flow chart is to define **OUT3** as **O5**(SP5) for example:



When stop, press  4 times, main display show “iodEF”.





Press  to input correct calibration password, then press  to define.



Main display show output and sub-display show code. Press  till main display show **OUT3**.



Press  till sub-display show **05**, then press  to finish, and press  to return.



Output code table:

Output		
Code	Definition	Description
00	None	No definition
01	Sp1	Effective output when present weight >= set point 1.

O2	Sp2	Effective output when set point 1 >present weight>=set point2.
O3	Sp3	Effective output when set point 2 >present weight>=set point3.
O4	Sp4	Effective output when set point 3 >present weight>=set point4.
O5	Sp5	Effective output when set point 4 >present weight>=set point5.
O6	Sp6	Effective output when present weight<set point 5.
O7	Stable	Effective output in stable status.
O8	Zero	Effective output at zero.
O9	Overflow	Effective output when overflow.
Input		
Code	Definition	Description
I1	Zeroing	Effective input for zeroing when weight value is stable in the zeroing range.

Note: Same input or output code can be defined by several inputs or output terminals, such as both of **IN1** and **IN2** can be defined I1 (zeroing).

5.6 Display testing

The following flow chart is to test lights on main-display and sub-display, status and instruction:

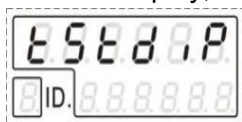

Press **MODE**  9 times in stop status till main display show "tStdip".



Press **ENTER**  till all of lights shine and sparkle at 2seconds/time.

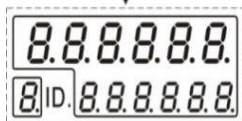

Press **ZERO/ESC**  2 times to exit testing and return.



5.7 Reset

Reset present parameters to initial setting.

Reset "I/O definition (io)" for example:

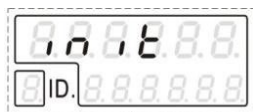

1. When stop, press  till main display show "init".



2. Press  to input correct calibration password.





3. Press  till sub-display show "io(I/O definition)".

Note: "SETUP" to backup operation parameters; "CAL" to backup calibration parameters; "rECiPE" to backup recipe parameters; "ALL" to reset all of parameters.

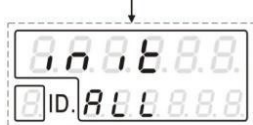

4. Press , sub-display show "YES?".



5. Press , sub-display show "SUCCEs" to enter next parameters. Press  to return.



1. Suggestion: When reset, please backup first to be used in the future.

5.8 Backup

User can make all of parameters backup.

Make “all of parameters(**ALL**)” backup for example:

1. When stop, press ^{MODE} till main display show “**bAC**”. And then press ^{ENTER} input calibration password, sub-display show “**SET UP**”.

2. Press ^{MODE} till sub-display show “**ALL** (all of parameters)”
Note: “**SETUP**” operation parameters backup; “**CAL**” calibration parameters backup; “**io**” I/O definition backup.

3. Press ^{ENTER} , sub-display show “**YES?**”, press ^{ENTER} to confirm and enter next parameters. Otherwise press ^{ZERO/ESC} to exit.

5.9 Restore backup

User can restore all of parameters to backup status.

Please refer backup instruction to operate, when main display show “**rbAC**”, confirm and restore.

5.10 Analog calibration

Calibrate at 4 values: **4mA**、**12mA**、**20mA** and maximum current.

1) **4mA**: Main display shows **CAL DA**, sub-display **10923** , ID indicates **1**;

2) **12mA**: Main display shows **CAL DA**, sub-display **32768**, ID indicates **2**;

3) **20mA**: Main display shows **CAL DA**, sub-display **54613**, ID indicates **3**;

maximum current: Main display shows **CAL DA**, sub-display **24.000**.

For example: calibrate “**12mA output**” and “**Max. current**” :



1. When stop, press **MODE** (right arrow) till main display show **CALdA**.

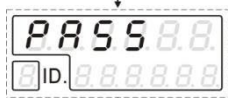

2. Press **ENTER** (center) to input calibration password.



3. Press **MODE** (right arrow), ID indicate from **1** to **2**, which means from **4mA** to **12mA**.

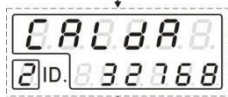

4. Calibrate when analog output is not **12mA** by multi-meter.

Press **ENTER** (center), sub-display sparkle, then press **MODE** (right arrow) to change **DA** digits to adjust analog output **12mA**, press **ENTER** (center) to finish.



User also can change **DA** digits according to the highest digit: Press **OPTION** (up arrow) when calibrate, then present highest digit sparkle, so press **MODE** (right arrow) to select and press **OPTION** (up arrow) and **MODE** (right arrow) in turn to change digits.

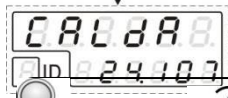

5. If ID doesn't display, which indicate the present value is maximum analog output, user can input present analog value now.

6. Press **ZERO ESC** (square) to exit.



1. Press **OPTION** (up arrow) long time in calibration, sub-display value for all of analog output restore to initial value.

5.11 Password

All initial passwords are : **000000**。 Note: Calibration password is same password as reset, backup, restore, I/O definition and analog calibration. When calibration password changed, others also changed.

Password operation as follows:



1. Press **ENTER** to enter password.

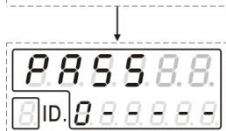

2. Press **OPTION** to input password.

Note: If input wrong, sub-display show **"Error"**, then press **ENTER** to input again. If Input wrong for three times, main display show **"Error4"** and self-lock, but user can operate again when power on again.

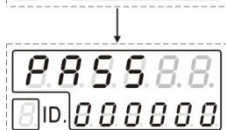

3. Input correct password, then press **ENTER** to set parameters.

5.12 Password setting

User can set password in parameters when **F6.1** is **"ON"**.
Set operation parameters password for example:

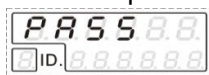

1. Press **ENTER**, main display show **F6.2**, then press **ENTER** to enter password.



Note: If **F6.1** is **OFF**, user can't enter password when press **ENTER**.

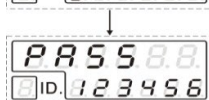

2. Press **OPTION** and **MODE** in turn to input password.





Note: User must input same new password twice in setting password. If not same, main display show **"Error"** one second and return to **PASS** again.





3. When input same new password twice, press **ENTER** to save and return **F6.2**.

5.13 Operation mode

Tuxon-MC has three modes: weighing mode, bagging mode and batching mode, which are optional for users.

Setting operation: When power on, press  long time in “8” sparkling till the indicator response two sonorants, then the indicator show“**PASS**”without pressing . After that, press  to input password “**880606**” on sub-display.

When password is correct, main display show “**SELECT**” and sub-display show **GM8806-A** (Weighing mode) 、**GM8806A-B** (Bagging mode) or **GM8806A-P** (Batching mode) , which can be switched by pressing .

After selecting operation mode, press  to confirm and finish, then the indicator sparkle “8” to enter.

Note: After selecting operation mode, user need reset the indicator to ensure parameters correct.

6 Serial port communication

Note: Not permit to change parameters related with serial port by serial ports.

Communication protocols: **RS/ RE/MODBUS**, which can be set in operation parameter **F4**.

6.1 RS protocol

Two modes: Continue (**Cont**) /Command (**Read**) at **ASCII** code.

6.1.1 Continue (Cont)

When operation parameter **F4.3** for **RS**、**F4.4** for **Cont**, indicator send weighing data to host computer without command.

Data Format:

STX	Scale no.	R	S	000	Status	+/-	Value	CRC	CR	LF
------------	------------------	----------	----------	------------	---------------	------------	--------------	------------	-----------	-----------

Here:

STX —— 1bit, start character **02H**

Scale no. —— 2bits, range at **01-99**, For example: **01** is **30H 31H**

R —— 1bit, **52H**

S —— 1bit, **53H**

000 —— 3bit, **30H 30H 30H**

Status —— 1bit, **4DH:M(stable)**; **53H:S(motion)** ; **4FH:**

O(overflow)

+/- —— 1bit, **+: 2B, -: 2D**

Value —— **7bits**, including radix point, if no, the highest bit is **0**.

CRC —— 2bits, check sum, means to add all of front digits and transform to algorism, and then transform the last two digits to **ASCII** code.

CR — 1bit, **0DH**

LF — 1bit, **0AH**

For example:

**02 30 31 52 53 30 30 30 4D 2B 30 30 30 30 39 31 36 38 30
0D 0A**

Means: 1# scale stable、 positive data、 present weight **916**.

6.1.2 Command (Read)

When operation parameter **F4.3** for **RS**、 **F4.4** for **Read**, indicator send weighing data to host computer after received command.

1) Host computer read present status

Read command:

STX	Scale no.	R	S	CRC	CR	LF
-----	-----------	---	---	-----	----	----

Correct response:

STX	Scale no.	R	S	000	Status	+/-	Value	CRC	CR	LF
-----	-----------	---	---	-----	--------	-----	-------	-----	----	----

Wrong response:

STX	Scale no.	R	S	N	O	CRC	CR	LF
-----	-----------	---	---	---	---	-----	----	----

Here:

N — 1bit, **4EH**

O — 1bit, **4FH**

For example:

02 30 31 52 53 36 34 0D 0A

Correct response:

**02 30 31 52 53 30 30 30 4D 2D 30 30 30 32 30 2E 30 36 36
0D 0A**

Means: 1# Scale、 stable, Present main display **-20.0**。

2)Host computer read “Set point”

Read command:

STX	Scale no.	R	Spx	CRC	CR	LF
-----	-----------	---	-----	-----	----	----

Correct response:

STX	Scale no.	R	Spx	DDDDDD	CR	CRC	LF
-----	-----------	---	-----	--------	----	-----	----

Wrong response:

STX	Scale no.	R	Spx	N	O	CRC	CR	LF
-----	-----------	---	-----	---	---	-----	----	----

Here:

Spx — 1bit, **1-5** means **31H**, **32H**, **33H**, **34H**, **35H**

DDDDDD — 6bits, set point value.

Read command on set point **1** for example:

02 30 31 52 31 33 30 0D 0A

Correct response:

02 30 31 52 31 30 30 30 37 30 30 32 35 0D 0A

Means set point 1 value is 700.

3) Host computer read radix point

Read command:

STX	Scale no.	R	P	CRC	CR	LF
-----	-----------	---	---	-----	----	----

Correct response:

STX	Scale no.	R	P	DDDDDD	CRC	CR	LF
-----	-----------	---	---	--------	-----	----	----

Wrong response:

STX	Scale no.	R	P	N	O	CRC	CR	LF
-----	-----------	---	---	---	---	-----	----	----

Here:

P — 1bit, **50H**

DDDDDD — 6bits, range at **0-4**, means radix point,
for example, **30H 30H 30H 30H 30H**

34H for 4bits radix point

Read radix point for example:

02 30 31 52 50 36 31 0D 0A

Correct response:

02 30 31 52 50 30 30 30 30 31 35 30 0D 0A

Means: **1#** scale radix point 1bit.

4)) Host computer read operation

parameters Read command:

STX	Scale no.	R	F	Parameters	0	CRC	CR	LF
-----	-----------	---	---	------------	---	-----	----	----

Correct response:

STX	Scale no.	R	F	Parameters	0	DDDDDD	CRC	CR	LF
-----	-----------	---	---	------------	---	--------	-----	----	----

Wrong response:

STX	Scale no.	R	F	N	O	CRC	CR	LF
-----	-----------	---	---	---	---	-----	----	----

Here:

F — 1bit, **46H**

Parameters — 3bits, for example: digit filter **F1.5** for **31H**

35H 30H

0 — 1bit, **30H**

DDDDDD — 6bits, operation parameter data

Read command operation parameter **F1.5** for example:

02 30 31 52 46 31 35 30 30 34 39 0D 0A

Correct response:

02 30 31 52 46 31 35 30 30 30 30 30 30 34 34 31 0D 0A

Means: **1#** scale **F1.5** is 4.

5) Host computer write set point value

Write command:

STX	Scale no.	W	Spx	DDDDDD	CRC	CR	LF
-----	-----------	---	-----	--------	-----	----	----

Correct response:

STX	Scale no.	W	Spx	O	K	CRC	CR	LF
-----	-----------	---	-----	---	---	-----	----	----

Wrong response:

STX	Scale no.	W	Spx	N	O	CRC	CR	LF
-----	-----------	---	-----	---	---	-----	----	----

Here:

W — 1bit, **57H**

Spx — 1bit, **1-5** means **31H**、**32H**、**33H**、**34H**、**35H**

DDDDDD — 6bits, set point value

K — 1bit, **4BH**

Write command set point **1** at **1500** on #1 scale for example:

02 30 31 57 31 30 30 31 35 30 30 32 39 0D 0A

Correct response :

02 30 31 57 31 4F 4B 38 39 0D 0A

Means: #1 scale have saved written data.

6)) Host computer write operation

parameters Write command:

STX	Scale no.	W	F	Parameters	0	DDDDDD	CRC	CR	LF
-----	-----------	---	---	------------	---	--------	-----	----	----

Correct response:

STX	Scale no.	W	F	O	K	CRC	CR	LF
-----	-----------	---	---	---	---	-----	----	----

Wrong response:

STX	Scale no.	W	F	N	O	CRC	CR	LF
-----	-----------	---	---	---	---	-----	----	----

Here:

W — 1bit, **46H**

Parameters — 3bits, for example, digit filter **F1.5 31H 35H 30H**

O — 1bit, **30H**

DDDDDD — 6bits, operation parameter value

Write command **F1.5** at **7** on **#1** scale for example:

02 30 31 57 46 31 35 30 30 30 30 30 30 37 34 39 0D 0A

Correct response:

02 30 31 57 46 4F 4B 31 30 0D 0A

Means: **#1** scale has saved **F1.5** at **7**.

7) Host computer zero calibration with weights

Write command:

STX	Scale no.	C	Z	CRC	CR	LF
-----	-----------	---	---	-----	----	----

Correct response:

STX	Scale no.	C	Z	O	K	CRC	CR	LF
-----	-----------	---	---	---	---	-----	----	----

Wrong response:

STX	Scale no.	C	Z	N	O	CRC	CR	LF
-----	-----------	---	---	---	---	-----	----	----

Here:

C — 1bit, **43H**

Z — 1bit, **5AH**

Write command zero calibration with weights on **#1** scale for example:

02 30 31 43 5A 35 36 0D 0A

Correct response:

02 30 31 43 5A 4F 4B 31 30 0D 0A

Means command has been performed correctly.

8) Host computer zero calibration without weights

Write command:

STX	Scale no.	C	Y	DDDDDD	CRC	CR	LF
-----	-----------	---	---	--------	-----	----	----

Correct response:

STX	Scale no.	C	Y	O	K	CRC	CR	LF
-----	-----------	---	---	---	---	-----	----	----

Wrong response:

STX	Scale no.	C	Y	N	O	CRC	CR	LF
-----	-----------	---	---	---	---	-----	----	----

Here:

Y — 1bit, **59H**

DDDDDD — 6bits, related zero millivolt, fixed 3bit radix point.

For example: Send **1.500mA** as zero calibration to #1 scale

02 30 31 43 59 30 30 31 35 30 30 34 39 0D 0A

Correct response:

02 30 31 43 59 4F 4B 30 39 0D 0A

Means data has been saved in #1 scale.

9) Host computer calibrate radix point

Write command:

STX	Scale no.	C	P	Radix point	CRC	CR	LF
-----	-----------	---	---	-------------	-----	----	----

Correct response:

STX	Scale no.	C	P	O	K	CRC	CR	LF
-----	-----------	---	---	---	---	-----	----	----

Wrong response:

STX	Scale no.	C	P	N	O	CRC	CR	LF
-----	-----------	---	---	---	---	-----	----	----

Here:

P — 1bit, **59H**

Radix point — 1bit, range at **0~4**

For example: calibrate radix point 3 on #1 scale

02 30 31 43 50 33 39 37 0D 0A

Correct response:

02 30 31 43 50 4F 4B 30 30 0D 0A

Means: Data has been saved in #1 scale.

10) Host computer calibrate minimum division and maximum

capacity

Write command:

STX	Scale no.	C	M	DD	DDDDDD	CRC	CR	LF
-----	-----------	---	---	----	--------	-----	----	----

Correct response:

STX	Scale no.	C	M	O	K	CRC	CR	LF
-----	-----------	---	---	---	---	-----	----	----

Wrong response:

STX	Scale no.	C	M	N	O	CRC	CR	LF
-----	-----------	---	---	---	---	-----	----	----

Here:

M — 1bit, **4DH**

DD — 2bits, division **1、 2、 5、 10、 20、 50**

DDDDDD — 6bits, maximum capacity

For example: Send division 1 and maximum capacity 10000 to #1 scale.

02 30 31 43 4D 30 31 30 31 30 30 30 30 32 39 0D 0A

Correct response:

02 30 31 43 4D 4F 4B 39 37 0D 0A

Means: Data has been saved in #1 scale.

1) Host computer gain calibration with weights

Write command:

STX	Scale no.	C	G	DDDDDD	CRC	CR	LF
-----	-----------	---	---	--------	-----	----	----

Correct response:

STX	Scale no.	C	G	O	K	CRC	CR	LF
-----	-----------	---	---	---	---	-----	----	----

Wrong response:

STX	Scale no.	C	G	N	O	CRC	CR	LF
-----	-----------	---	---	---	---	-----	----	----

Here:

G — 1bit, **47H**

DDDDDD — 6bits, weights value

Send command gain calibration to #1 scale for example:

02 30 31 43 47 30 31 30 30 30 30 32 36 0D 0A

Correct response:

02 30 31 43 47 4F 4B 39 31 0D 0A

Means: Written **10000** have been saved in #1 scale.

12) Host computer gain calibration without weights

Write command:

STX	Scale no.	C	L	D ₁ D ₁ D ₁ D ₁ D ₁ D ₁	D ₂ D ₂ D ₂ D ₂ D ₂ D ₂	CRC	CR	LF
-----	-----------	---	---	---	---	-----	----	----

Correct response:

STX	Scale no.	C	L	O	K	CRC	CR	LF
-----	-----------	---	---	---	---	-----	----	----

Wrong response:

STX	Scale no.	C	L	N	O	CRC	CR	LF
-----	-----------	---	---	---	---	-----	----	----

Here:

L — 1bit, **4CH**

D₁D₁D₁D₁D₁D₁ — 6bits, gain millivolt

D₂D₂D₂D₂D₂D₂ — 6bits, weight value

For example: Calibrate **4.110mA** as **10000**

02 30 31 43 4C 30 30 34 31 31 30 30 31 30 30 30 30 32 35 0D 0A

Correct response:

02 30 31 43 4C 4F 4B 39 36 0D 0A

Means: Written data has been saved in #1 scale.

13) Host computer zeroing operation

Write command:

STX	Scale no.	C	C	CRC	CR	LF
-----	-----------	---	---	-----	----	----

Correct response:

STX	Scale no.	C	C	O	K	CRC	CR	LF
-----	-----------	---	---	---	---	-----	----	----

Wrong response:

STX	Scale no.	C	C	N	O	CRC	CR	LF
-----	-----------	---	---	---	---	-----	----	----

Zeroing operation on #1 for example:

02 30 31 43 43 33 33 0D 0A

Correct response:

02 30 31 43 43 4F 4B 38 37 0D 0A

Means zeroing operation has been performed correctly.

6.2 RE protocols

Two modes: Continue (**Cont**)/ command (**Read**).

Support all of data format in parameters **F4.5**; **ASCII** code.

6.2.1 Continue mode (Cont)

When operation parameters **F4.3** for **RE**、**F4.4** for **Cont**, indicator send data to host computer without any command.

Data format as follows:

Status	,	GS	,	Sign	Value	Unit	CR	LF
--------	---	----	---	------	-------	------	----	----

Here:

Status —— 2bits, **OL**: (**4FH 4CH**) overflow; **ST**: (**53H 54H**)stable **US**: (**55H 53H**)unstable

, —— 1bit, list separator **2CH**

GS —— 2bits, **47H 53H**

Sign —— 1bit, **2BH** (+)、**2DH** (-)

Value —— 7bits, including radix point, if no, the highest bit is **0**

Unit — 2bits, **Kg 4BH 67H**

CR — 1bit, **0DH**

LF — 1bit, **0AH**

For example: Indicator sends following data format automatically:

53 54 2C 47 53 2C 2B 30 31 31 2E 31 32 30 4B 67 0D 0A

Means : stable、 positive data、 present weight value is **11.**

120kg

6.2.2 Command mode (Read)

When operation parameters **F4.3** for **RE**、 **F4.4** for **Read**、 indicator send present data to host computer only after received command .

Data format as follows:

R	E	A	D	CR	LF
----------	----------	----------	----------	-----------	-----------

Here :

R — **52H**

E — **45H**

A — **41H**

D — **44H**

CR — **0DH**

LF — **0AH**

Response data format is same as continue mode.

For example

Command: **52 45 41 44 0D 0A**

Response: **53 54 2C 47 53 2C 2B 30 31 31 2E 31 32 30 4B 67 0D 0A**

Means: stable、 positive data、 present weight value is **11.**
120kg.

6.3 MODBUS protocol

6.3.1 Communication mode

MODBUS communication by two mode: **RTU** and **Asc**。

When parameter **F4.4** is **RTU**, every 8-bit byte of the message are divided into 2pcs of 4-bit hexadecimal characters to transmit at binary code. Data format: **8- E-1**, **8- O-1**, **8- n-1**, **8- n-2**。

When parameter **F4.4** is **ASCII**, every 8-bit byte of the message is transmitted as 2pcs **ASCII** characters at **ASCII** code, which can support all of data format in parameter **F4.5**.

6.3.2 MODBUS address

PLC address	Display address	Description
The following items are only-read register(function code		
40001	0000	Present weight value(4bits including sign characters, the high bit is in the front)
40002	0001	
40003	0002	D0 (0 stable、 1 unstable); D1 (0 normal、 1 overflow); D2 (0 none-zero、 1 zero) D4 (0 positive sign、 1 negative sign); D5 (0 sp1 ineffective、 1 sp1 effective); D6 (0 sp2 ineffective、 1 sp2 effective); D7 (0 sp3 ineffective、 1 sp3 effective); D8 (0 sp4 ineffective、 1 sp4 effective); D9 (0 sp5 ineffective、 1 sp5 effective); D10 (0 sp6 ineffective、 1 sp6 effective);
40004	0003	Reserve(permit to read, reading value is 0)
.....	
40007	0006	

The following items two bytes which are available for read and writing (writing code 0x06 , read code 0x03)		
40008	0007	Automatically zeroing when power on. (F1.1)
40009	0008	Zero tracking range (F1.2)
40010	0009	Zeroing range (F1.3)
40011	0010	Stable range (F1.4)
40012	0011	Digit filter parameters(0-9) (F1.5)
40013	0012	Stability filter series(0-9) (F1.6)
40014	0013	Analog output mode (F3.1)
40015	0014	Analog inverting input (F3.2)
40016	0015	I/O output stability (F5.1)
40017	0016	Sub-display items (F5.2)
40018 40021	0017 0020	Reserve (read value 0 , no any operation when write. Suggest had better not write in order to update in the future.)
40022	0021	Radix point (0- 4)
40023	0022	Minimum division (0- 5 means 1/ 2/ 5/ 10/ 20/ 50)
40024	0023	Load cell sensitivity (0- 1 means 2mV/V、 3mV/V)
40025 40034	0024 0033	Reserve (read value 0 , no any operation when write. Suggest had better not write in order to update in the future.)

The following items are four bytes and available to read and write(writing code 0x10 , read code 0x03)		
0031-0032	0030-0031	Maximum capacity(max.capacity≤mini.division× 30000)
0033-0034	0032-0033	Zero calibration with weights Write 0001H to take present weight as zero when weight value is stable; Read to return present millivolt at zero. (Note 1)。
40035-40036	0034-0035	Gain calibration with weights Write present weight value according to present millivolt; Read to return present millivolt at present weight value.
40037-40038	0036-0037	Zero calibration without weights Write millivolt value to be zero; Read to return present zero millivolt value.
40039-40040	0038-0039	Gain calibration without weights, input gain millivolt. Write gain millivolt value related gain weight, indicator save first; Read to return millivolt value related present weight.
40041-40042	0040-0041	Weight gain calibration without weights, input gain weight value (≤maximum capacity) . Write weight value related gain millivolt after writing gain millivolt first, gain calibration in this register by both of weight and millivolt; Read to return 0000H .

40043-40044	0042-0043	Set point 1 (F2.1)
40045-40046	0044-0045	Set point 2 (F2.2)
40047-40048	0046-0047	Set point 3 (F2.3)
40049-40050	0048-0049	Set point 4 (F2.4)
40051-40052	0050-0051	Set point 5 (F2.5)
40053..... 40056	0052..... 0055	Reserve (read value 0 , no any operation when write. Suggest had better not write in order to update in the future.)
The following items are bit read only. (read code: 0x01)		
00057	0056	0 : Stable; 1 : Unstable
00058	0057	0 : Normal; 1 : Overflow
00059	0058	0 : None-zero; 1 : Zero
00060	0059	0 : Positive sign; 1 : negative sign
00061	0060	SP1 output effective (0 ineffective; 1 effective)
00062	0061	SP2 output effective (0 ineffective; 1 effective)
00063	0062	SP3 output effective (0 ineffective; 1 effective)
00064	0063	SP4 output effective (0 ineffective; 1 effective)
00065	0064	SP5 output effective (0 ineffective; 1 effective)
00066	0065	SP6 output effective (0 ineffective; 1 effective)
00067 00075	0066 0074	Reserve (read value 0 , no any operation when write. Suggest had better not write in order to update in the future.)
The following item are available to read and write (read code: 0x01 , writing code: 0x05)		
00076	0075	Zeroing (write FF00); read to return fixed 0

6.3.3 Function code

Above **Modbus** communication protocols have five function codes: **01** read coil、**03** read register、**05** force single coil、**06** preset single register、**16(10 Hex)** preset several registers.

01 read coil

Inquiry: Regulate coil start and quantities.

Response:

- a) Every coil state in response message is corresponding to every data in data area; **1=ON; 0=OFF**.The **LSB** in first byte is start address in inquiry. Other coils are in seriation from lowest to highest in the byte till full of 8pcs, next byte same seriation.
- b) If they are not 8 multiples, the last byte is full of zero from the remain to the highest, which byte sections indicate all of byte quantities.

For example: Inquiry weighing indicator **01** to read **40- 43** coil

1) **RTU communication mode:**

Inquiry command:

Address	Function code	Start address	Coil quantity	CRC parity
1byte	1byte	2byte	2byte	2byte

Correct response:

Address	Function code	Account byte	Data area	CRC parity
1byte	1byte	1byte	1byte	2byte

Inquiry command: **01 01 00 28 00 04 BD C1**

Correct response: **01 01 01 02 D0 49** (Coil **43- 40** related state: **0- 0- 1- 0**)

2) **ASCII communication mode:**

Inquiry command:

Start	Address	Function code	Start address	Coil quantities	LRC parity	Stop
1byte	2byte	2byte	4byte	4byte	2byte	2byte

Correct response:

Start	Address	Function code	Account byte	Data area	LRC parity	Stop
1byte	2byte	2byte	2byte	2byte	2byte	2byte

Inquiry command: **3A 30 31 30 31 30 30 32 38 30 30 30 34 44 32 0D 0A**

Correct response: **3A 30 31 30 31 30 31 30 32 46 42 0D 0A**

(Coil 43- 40 related status: 0- 0- 1- 0)

03 read register

Inquiry: Regulate to read register start address and register quantities.

Response: Regulate read register byte quantities, every register relate 2bytes respectively; Message also has data from every read register.

For example: read register **0007**、**0008**。

1) RTU communication mode:

Inquiry command:

Address	Function code	Start address	Inquiry register quantity	CRC parity
1byte	1byte	2byte	2byte	2byte

Correct response:

Address	Function code	Account byte	Register (0007) data	Register (0008) data	CRC parity
1byte	1byte	1byte	2byte	2byte	2byte

Inquiry command: **01 03 00 07 00 02 75 CA**

Correct response: **01 03 04 00 00 00 05 3A 30** (Register **0007**、**0008** respective data: **0** (Hex: **0000H**)、**5** (Hex: **0005H**))

2) ASCII communication mode:

Inquiry command:

Start	Address	Function code	Start address	Inquiry register quantity	LRC parity	Stop
1byte	2byte	2byte	4byte	4byte	2byte	2byte

Correct response:

Start	Address	Function code	Account byte	Register (0007) data	Register (0008) data	LRC parity	Stop
1byte	2byte	2byte	2byte	2byte	2byte	2byte	2byte

Inquiry command: **3A 30 31 30 33 30 30 30 37 30 30 30 32 46 33 0D 0A**

Correct response: **3A 30 31 30 33 30 34 30 30 30 30 30 30 30 35 46 33 0D 0A** (register 0007、0008 respective data : **0 (Hex: 0000H)、5 (Hex: 0005H)**)

05 force single coil

Force: Regulate force coil address; and one normal item in force data area, regulate requested coil **ON/ OFF** state: **FF00** for **ON**, **0000H** for **OFF**, other data is ineffective to coil.

Response: Return normal response for force coil.

For example: Force weighing indicator **01**, **0056** coil is **ON**

1) RTU communication mode:

Force command:

Address	Function code	Coil address	Force data	CRC parity
1byte	1byte	2byte	2byte	2byte

Correct response:

Address	Function code	Coil address	Force data	CRC parity
1byte	1byte	2byte	2byte	2byte

Force command: **01 05 00 38 FF 00 0D F7**

Correct response: **01 05 00 38 FF 00 0D F7** (Coil **0056** is **ON**)

2) ASCII communication mode:

Force command:

Start	Address	Function code	Coil address	Force data	LRC parity	Stop
1byte	2byte	2byte	4byte	4byte	2byte	2byte

Correct response:

Start	Address	Function code	Coil address	Force data	LRC parity	Stop
1byte	2byte	2byte	4byte	4byte	2byte	2byte

Force command: **3A 30 31 30 35 30 30 33 38 46 46 30 30 43 33 0D 0A**

Correct response: **3A 30 31 30 35 30 30 33 38 46 46 30 30 43 33 0D 0A** (Coil**0056** is **ON**)

06 preset single register

Preset: Regulate to preset single register address and data.

Response: Return normal response after register is preset.

For example: Request **0009** register in weighing indicator **01** is preset **0005H**

1) RTU communication mode:

Preset command:

Address	Function code	Preset register address	Preset data	CRC parity
1byte	1byte	2byte	2byte	2byte

Correct response:

Address	Function code	Preset register address	Preset data	CRC parity
1byte	1byte	2byte	2byte	2byte

Preset command: **01 06 00 09 00 05 99 CB**

Correct response: **01 06 00 09 00 05 99 CB** (register **0009**data: **5** (Hex: **0005H**))

2) ASCII communication mode:

Preset command:

Start	Address	Function code	Preset register address	Preset data	LRC parity	Stop
1byte	2byte	2byte	4byte	4byte	2byte	2byte

Correct response:

Start	Address	Function code	Preset register address	Preset data	LRC parity	Stop
1byte	2byte	2byte	4byte	4byte	2byte	2byte

Presetcommand: **3A 30 31 30 36 30 30 30 39 30 30 30 35 45 42 0D 0A**

Correct response: **3A 30 31 30 36 30 30 30 39 30 30 30 35 45 42 0D 0A** (register **0009** data: **5** (Hex: **0005H**))**16** (**10 hex**) **Preset several registers**

Preset: Regulate to preset register start address and preset value.

Response: Return address, function code, start address and preset register quantity.

For example: Preset 2 registers in weighing indicator **01**: start register is **0030**. Preset value is **0001H** and **7318H**

1) RTU communication mode:

Preset command:

Address	Function code	Start address	Register quantity	Account byte	Preset data	CRC parity
1byte	1byte	2byte	2byte	1byte	4byte	2byte

Correct response:

Address	Function code	Start address	Register quantity	CRC parity
1byte	1byte	2byte	2byte	2byte

Preset command: **01 10 00 1E 00 02 04 00 01 73 18 07 D5**

Correct response: **01 10 00 1E 00 02 21 CE**

2) **ASCII communication mode:**

Preset command:

Start	Address	Function code	Start address	Register quantity	Account byte	Preset data	LRC parity	Stop
1byte	2byte	2byte	4byte	4byte	2byte	8byte	2byte	2byte

Correct response:

Start	Address	Function code	Start address	Register quantity	LRC parity	Stop
1byte	2byte	2byte	4byte	4byte	2byte	2byte

Preset command: **3A 30 31 31 30 30 30 31 45 30 30 30 32**

30 34 30 30 30 31 31 43 39 36 31 38 0D 0A

Correct response: **3A 30 31 31 30 30 30 31 45 30 30 30 32 43**

46 0D 0A

6.3.4 MODBUS communication error message

When weighing indicator check other error message except parity code (**CRC** or **LRC**), indicator will send message to host computer, the highest in function code is **1**, which means function code from weighing indicator to host computer is added **128** based on function code from host computer (For example: read register command **03H** will be changed to **83H**).

Error code:

02: error data address; Received data address is not permitted by weighing indicator.

03: error data; Inquiry data is not permitted by weighing indicator.

For example: Host computer read coil (**0040**) by function code **03**.

Error message format: 1)

RTU communication mode:

Address	Function code	Error code	CRC parity
1byte	1byte	1byte	2byte

2) ASCII communication mode:

Start	Address	Function code	Error code	LRC parity	Stop
1byte	2byte	2byte	2byte	2byte	2byte

1) RTU communication mode:

Inquiry command: **01 03 00 28 00 01 04 02**

Error response: **01 83 02 C0 F1**

2) **ASCII communication mode:**

Inquiry command: **3A 30 31 30 33 30 30 32 38 30 30 30 31 44 33 0D 0A**

Error response: **3A 30 31 38 33 30 32 37 41 0D 0A**

From response message, the present error code is **02**, which means the present received data address is error, not permit by weighing indicator.

7 Error and alarm message

ERROR : Input wrong data beyond parameter range.

ERROR2: The present weight value is out of zeroing range.

ERROR3: Scale platform is not stable when zeroing.

ERROR4: Input wrong password more than 3 times.

OVER : The load cell sign is too heavy when zero calibration.

UNDER : The load cell sign is too light when zero calibration.

OFL : Overflow