



USER MANUAL

AKA, AKZ SERIES

Contents:

1. General description	4
2. Set.....	4
3. Safety rules	5
4. Technical data	6
5. General balance description	7
6. Keys and indicators	9
7. Preparing working environment	10
8. Preparing balance to work	11
9. General operation principles.....	12
10. Internal calibration (only AKA)	13
11. Checking the balance	15
12. Connecting the balance to computer or printer	15
13. Start-up	19
14. Weighing with tare	20
15. Scale menu	21
16. Menu navigation rules	22
17. Scale setup (SEtUP)	28
17.1 Scale calibration (CALIb)	29
17.2 Autozeroing function (AutotAr)	33
17.3 Weight unit selection (UnIt)	34
17.4 Serial port parameters setting (SErIAL).....	35
17.5 Printout configuration (PrInt)	36
17.6 Weighing speed selection (SPEED).....	38
17.7 Analog out configuration (AnALOG) – option	39
18. Special functions description.....	40
18.1 Product and user identification (Prod and USEr).....	41
18.2 Pieces counting function (PCS).....	43
18.3 Percentage weighing function (PErC)	44

18.4	<i>Label choosing function (LAbEL)</i>	45
18.5	<i>Weighing animals function (LOC)</i>	46
18.6	<i>Constant tare memory function (tArE)</i>	47
18.7	<i>Maximum value indication function (UP)</i>	49
18.8	<i>Total weight function (totAL)</i>	50
18.9	<i>Checkweighing function (thr)</i>	52
18.10	<i>Setting date and time function (dAtE)</i>	55
18.11	<i>Statistical calculations function (StAt)</i>	56
18.12	<i>Function for summing recipe ingredients (rECIPE)</i>	59
18.13	<i>Density determination (dEnSItY)</i>	60
19.	<i>Troubleshooting and maintenance</i>	63

1. General description

AKA/AKZ series balances are destined for high accuracy weighing in laboratory practice.

All balances are metrologically tested. According to an order balances can be calibrated or legally verified.

Balances with legal verification comply with certificate of type approval and are marked with the following legal and securing items:

- green metrological mark placed on the balance name plate,
- notified body stamp (number of notified body) on the balance name plate,
- protective seals placed on: an edge of balance name plate, the casing mounting screw and in the place of access to adjustment switch,

In order to renew legal verification please contact authorized service of AXIS.

Balance classification according to PKWiU: 33.20.31.

Certificates:

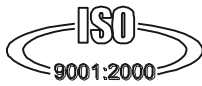

Certificate of ISO quality system
DIN EN ISO 9001:2000

Certificate of balance type approval

2. Set

A standard set consist of:

1. Balance,
2. Pan support and a pan,
3. Feeder 12V / 1,2A,
4. User manual,
5. Guarantee card

3. Safety rules

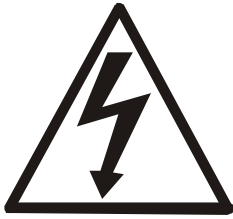

It is necessary to follow safety rules of work with the balance shown below. Obeying those rules is the condition to avoid electrical shock or damage of the balance or connected peripheral devices.

- Repairs and necessary regulations can be done by authorised personnel only.
- To avoid fire risk use a feeder of an appropriate type (supplied with the balance) and supply voltage have to be compatible with specified technical data.
- Do not use the balance when its cover is opened.
- Do not use the balance in explosive conditions.
- Do not use the balance in high humidity environment.
- If the balance seems not to operate properly, switch it off and do not use until checked by authorised service.



According to current acts of law about protection of natural environment, wasted balances should not be put into waste containers together with ordinary waste.

- Wasted balance after operation period can be delivered to units authorized for gathering wasted electronic devices or to the place where it was bought.

4. Technical data

Type	AKA120 AKZ120	AKA220 AKZ220	AKA320 AKZ320	AKA520 AKZ520
Load (Max)	120g	200g	300g	500g
Load (Min)	0,02g	0,02g	0,02g	0,02g
Readout unit (d)	0,001g	0,001g	0,001g	0,001g
Verification unit (e)	0,01g	0,01g	0,01g	0,01g
Tare range	-120g	-200g	-300g	-500g
Accuracy	II			
Repeatability	0,001mg			
Non-linearity	±0,002mg			
Work temp.	+18 ÷ +35°C			
Weighing time	<3s			
Pan size	φ115mm			
Balance dim. (with legs)	215(235 with legs)x345x90mm			
Interface and equipment	RS232C, USB, PS2, clock (option: LAN or Wi-Fi)			
Supply	~230V 50Hz 6VA / =12V 1,2A			
Scale weight	5kg			
Recommended standard of mass	F2 100g	F2 200g	F2 200g	F1 500g

Type	AKA1200 AKZ1200	AKA2200 AKZ2200	AKA3200 AKZ3200	AKA4200 AKZ4200	AKZ10
Load (Max)	1200g	2200g	3000g	4200g	10kg
Load (Min)	0,5g	0,5g	0,5g	0,5g	5g
Readout unit (d)	0,01g	0,01g	0,01g	0,01g	0,1g
Verification unit (e)	0,1g	0,1g	0,1g	0,1g	1g
Tare range	-1200g	-2200g	-3000g	-4200g	-10kg
Accuracy	II				
Repeatability	0,01g				0,1g
Non-linearity	±0,02g				±0,2g
Work temp.	+18 ÷ +33°C				
Weighing time	<3s				
Pan size	165x165mm				195x180mm
Balance dim. (with legs)	215(235 with legs)x345x90mm				
Interface and equipment	AKA/G or AKZ/G: RS232C, USB, PS2, clock (optional: LAN or Wi-Fi) AKA or AKZ: RS232C (optional: USB, PS2, clock, LAN or Wi-Fi)				
Supply	~230V 50Hz 6VA / =12V 1,2A				
Scale weight	5kg				
Recommended standard of mass	F2 1000g	F2 2000g			F2 5000g

Caution:

E2 is international symbol of calibration weight class according to O.I.M.L. Some requirements for weight accuracy are connected with this class.

5. General balance description

AKA100-AKA520, AKZ100-AKZ520 balances:

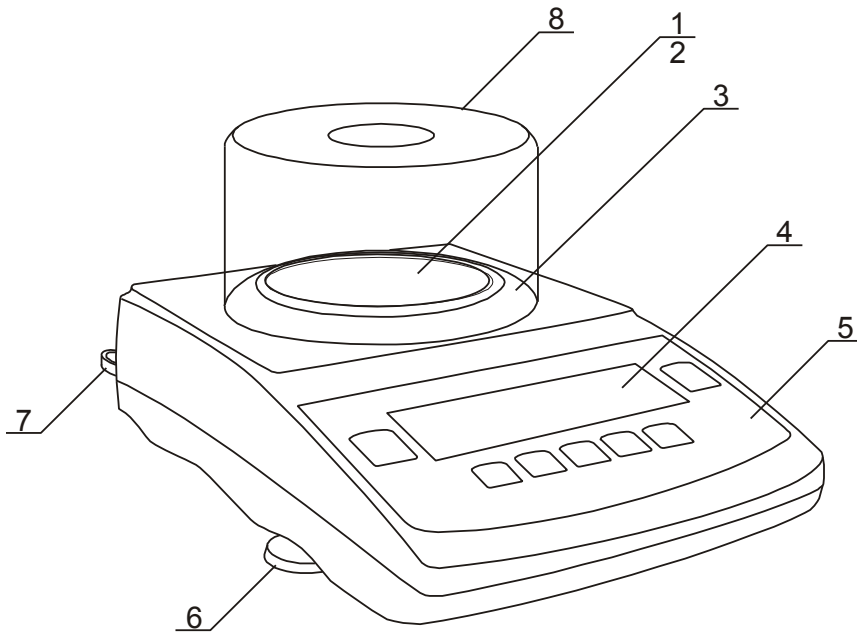

- 1 – pan
- 2 – pan support
- 3 – pan ring
- 4 – display LCD
- 5 – keys
- 6 – rotating legs
- 7 – water level
- 8 – draft shield

AKA1200-AKA4200 , AKZ1200-AKZ10 balances:

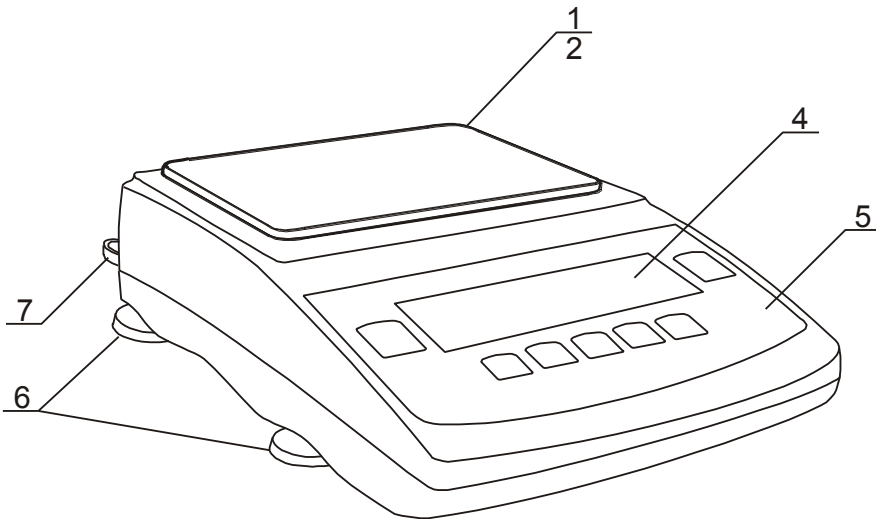

- 1 – pan
- 2 – nuts (under pan)
- 4 – LCD display
- 5 – keys
- 6 – rotating legs
- 7 – water level

Connectors view:

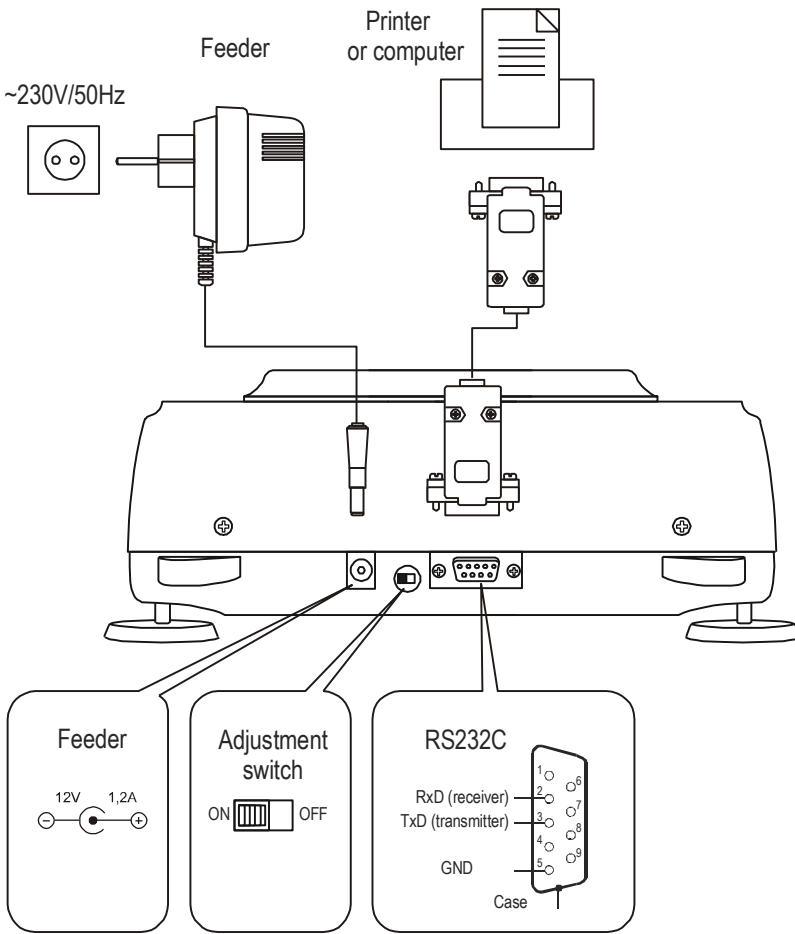

6. Keys and indicators

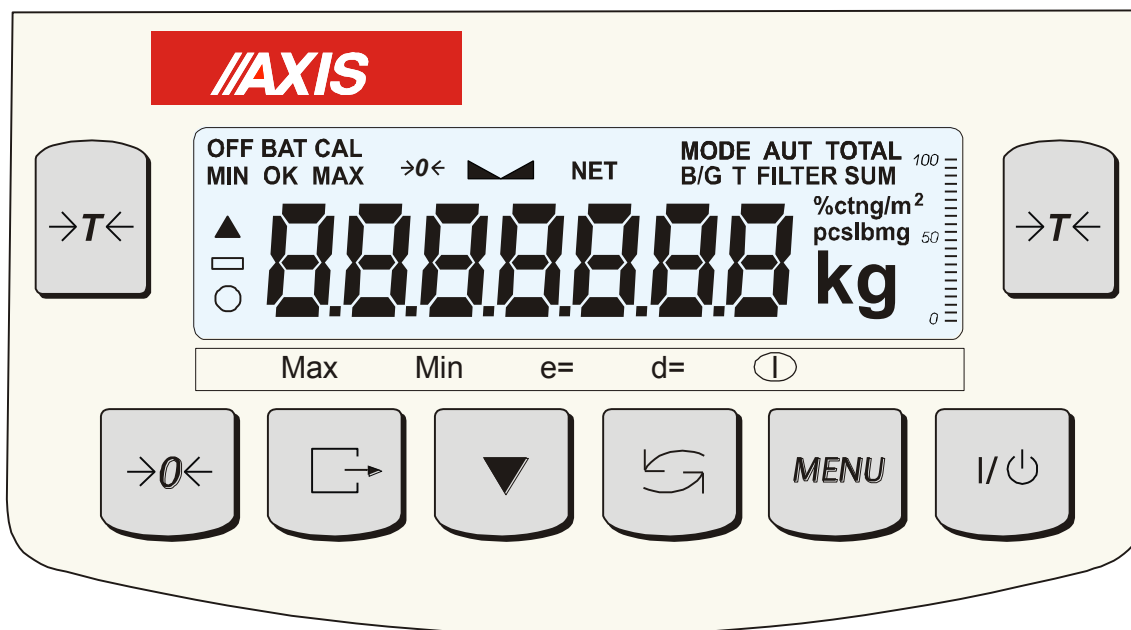

Description of basic key functions and indicators:

→T←	-	tarring (enter mass subtracted from weighed mass)/ confirmation of selected menu options,
→0←	-	zeroing (option),
	-	result printout (transmission),
	-	internal calibration,/ accelerated options viewing
	-	switch: special function/ weighing,
MENU	-	enter to special function menu,
I/⏻	-	switch on / switch off (standby),
	-	shows stabilization of weighing result,
linear indicator	-	indicator of balance load (0-100%),
OFF indicator	-	appears after the balance is switched off with I/⏻ key,
distinction of last digit	-	informs that reading unit value is lower than acceptable indication error (balances with legal verification, d≠e)
Max, Min, d, e, I	-	metrological parameters of the balance.

The use of keys during entering numeric values (special functions):

- increment current digit,
- insert comma,
- T← - move to next position,
- MENU - finish entering.

7. Preparing working environment

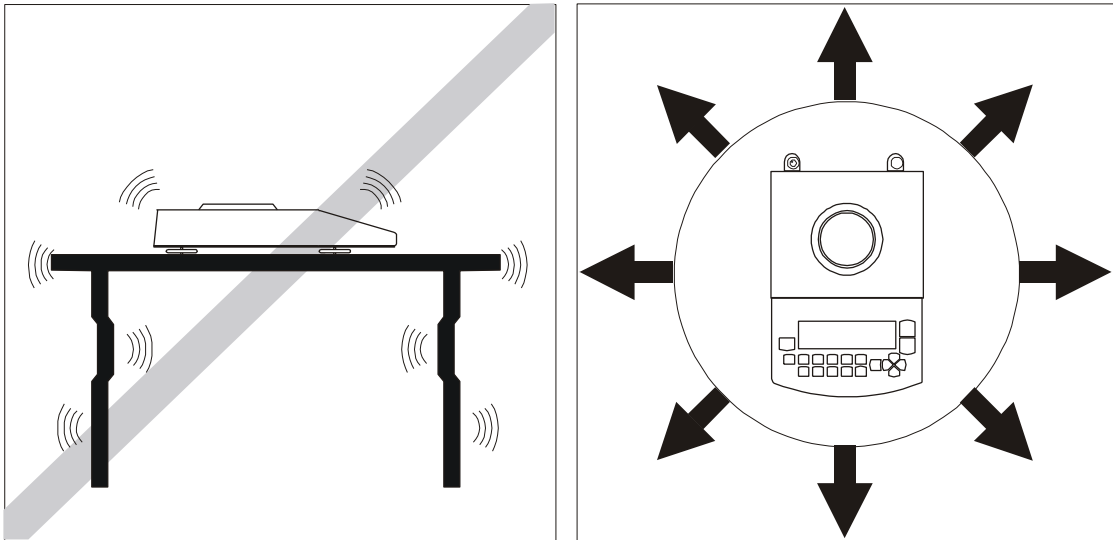
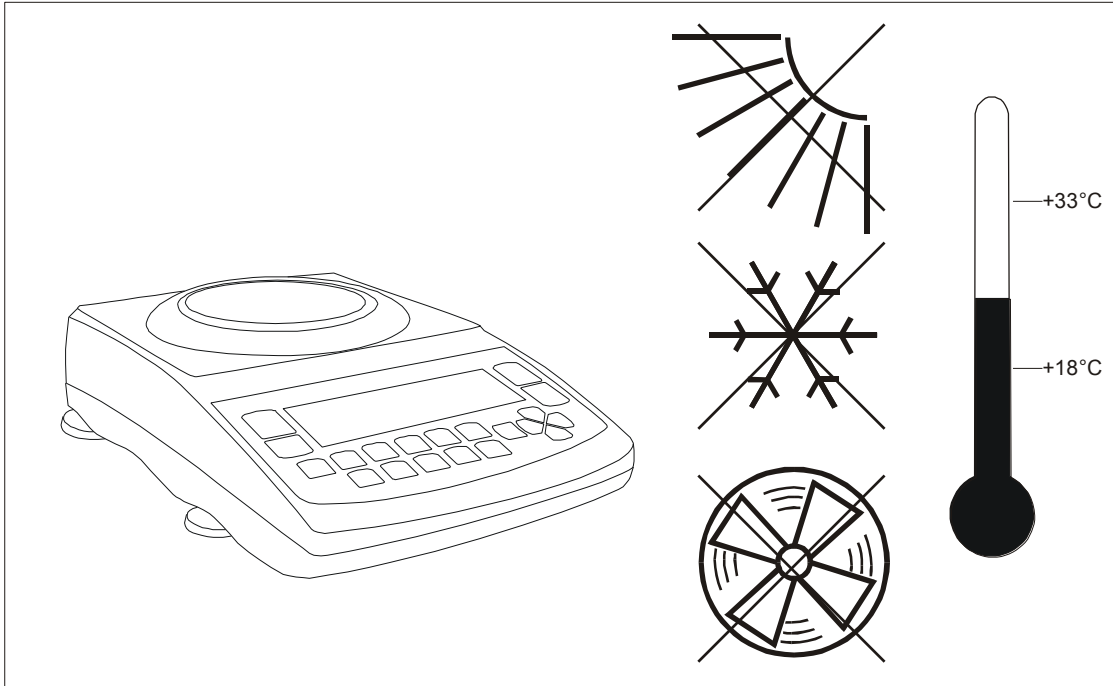

Location for the balance should be chosen with care in order to limit influence of the factors that can interrupt working balance. This location has to maintain proper temperature for working balance and necessary space for its operating. The balance should stay on stable table made of material that does not influence magnetically on the balance.

Rapid air blasts, vibrations, dust, rapid temperature changes or air humidity over 75% are not allowed in balance surrounding. The balance should be far from heat sources and devices emitting strong electromagnetic or magnetic fields.

8. Preparing balance to work

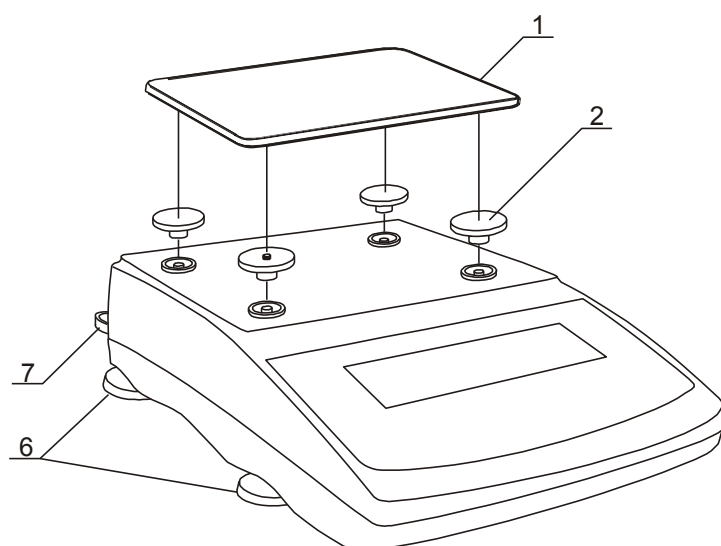
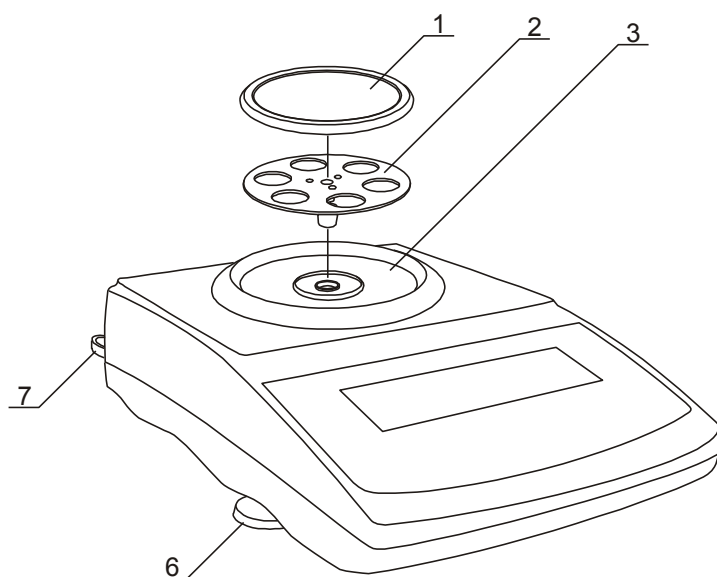

1. Take the balance, the feeder and mechanical elements of the pan out. It is recommended to keep the original scale package in order to transport the balance safely in future.

2. Place the balance on a stable ground not affected by mechanical vibrations and airflows.

3. Level the balance with rotating legs 6 so that the air bubble in water level 7 at the back of the balance is in the middle.

4. (for AGC100-AGC600) Gently insert the mandrel of pan support 2 into balance mechanism socket through the pan ring 3 and the pan 1 on (AGC600 balances have not pan ring).

5. (for AGC1000-AGC4000, AGZ10C) Place nuts 2 on mandrels that are visible in balance cover holes, put the pan 1 on nuts.



If the balance was taken from a lower temperature surrounding to a room with higher temperature, e.g. in winter, moisture can liquefy on the balance casing. Do not connect power supply to the balance, because this can cause damage or improper work of the balance. In this case leave the balance for at least 4 hours unplugged for acclimatization.

9. General operation principles



Do not overload the balance more than 20% of maximum capacity.
Do not press the pan with a hand.



For transportation take off the pan (move it gently and lift it up) and pan support (lift it up) and protect from any damages.

1. Weighed sample should be placed in the centre of the pan.
2. Weighing result should be read when the indicator "▲ ▼" lights, which signals stabilisation of a result.
3. The balance allows tarring in the whole measuring range. To tare the balance press $\rightarrow T \leftarrow$ key (on the left or on the right). Tarring does not extend measuring range, but only subtracts tare value from mass value of a sample placed on the pan. To make the control of pan load easier and to avoid crossing measurement range, the balance has a load indicator calibrated 0=100% Max.
4. In direct sale use (d=e), make sure that $\square 0$ zero indicator is displayed before sample is placed on the pan. If not, press $\square 0$ key and wait until the balance is zeroed and zero indicator appears. In other balances the key does not operate.
5. When the balance is not used but should be ready to work immediately, it can be switched off by pressing I/ϕ key. The backlight of balance reading system is then switched off and the balance enters into "standby" mode, in which the balance maintains internal temperature and ability to start working with maximum accuracy. Standby mode is signalled by the *OFF* indicator. To switch the balance on press I/ϕ key.
6. The balance cannot be used to weigh ferromagnetic materials due to decrease of weighing accuracy.
7. Balance mechanism is a precise device sensitive to mechanical shocks and strokes.
8. After every change of balance position, level the balance and perform internal calibration using \blacktriangledown key.

10. Internal calibration (only AKA)

The balance is equipped with internal calibration system, which general task is to maintain required measurement accuracy on the balance.

Internal calibration is the process of putting internal weight on automatically by balance mechanism and correcting accuracy in balance firmware. The correction is necessary because of differences between values of gravitational acceleration in the place where the balance was manufactured and in the place where it is operated, as well as due to changes of balance level and temperature.

Internal calibration is performed in the following situations:

- when ▼ key is pressed,
- after defined time interval (for legally verified balances - 2 hours),
- after temperature change (for legally verified balances – more than 2°C).

In legally verified balances time interval is set to 2 hours and defined temperature change is 2°C. In not legally verified balances those values can be set as calibration options. The reason of starting internal calibration is shown as an icon near weight picture.

In order to perform internal calibration proceed with the following:

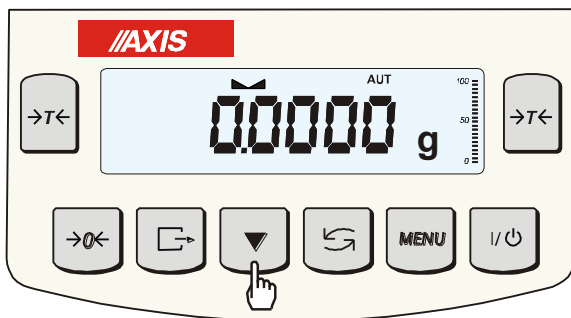

P r e s s



A C A I n

A t A . 0 1

A t A 1 0 0

- d o w n -

- u p -

- - - - -



~45 seconds



Empty the pan.

Press ▼ key twice (double pressing the key helps to avoid accidental starting calibration procedure).

During calibration internal weight is put three times on and obtained results are compared. Discrepancy of results is signalled with a message and causes the balance being blocked. Until calibration process is finished do not perform any operation on the balance. Any vibrations and shocks interfere calibration process and may delay it or deteriorate accuracy of its result.

When internal calibration is performed successfully the balance indicates zero on the display at empty pan.

Note:

In order to terminate calibration process in not legally verified balances press ▼ key and wait until balance mechanism is not settled in initial position.

11. Checking the balance

In order to confirm correctness of the balance during its operation, before starting and after finishing every measurement series it is advised to check weighing accuracy. It can be done by weighing external calibration weight or other object with exactly known mass.

If exceeding of allowable measurement error is affirmed, the following things should be checked:

- if the balance stands stable and it is levelled,
- if the balance is exposed on rapid air blasts, vibrations, rapid temperature changes or air humidity,
- if the balance is not affected directly by heat source, electromagnetic radiation or magnetic field.



The cause of inaccuracy can be too low temperature of the balance as well, when it was unplugged from power supply. In this situation leave the balance switched on for several minutes in order to adjust its internal temperature.

If none of above causes of inaccuracy occurs, calibration with external weight should be performed to the balance. Recommended external calibration weight (to buy for additional charge) is given in technical data table. In order to calibrate the balance with external weight in legally verified balances verification seals should be removed and another legal verification should be performed. In this case it is recommended to contact authorized service centre.

Calibration with external weight is described in details in chapter 17.1.

12. Connecting the balance to computer or printer

The scale can be equipped with one or two serial interfaces RS232C, USB, LAN or Wi-Fi designed to cooperate:

- with computer – the scale sends data after pressing  key or after initiation signal from computer,
- with printer - sending data after pressing  key or automatically after putting on/off a sample and measurement stabilization,
- with label printer – after pressing  the scale sends set of instructions for label printer starting from label number set in special function *LabEL*.

Set of send data is set using special function *Print*.

The following data can be send:

- Header (scale type, Max, d, e, serial number),
- Operator identification number,
- Successive printout number (measurement),
- Identification number or product bar code,
- Number of pcs (PCS function only),
- Single detail mass (PCS function only),
- Nett weight,
- Tare (package mass),
- Gross weight,
- Total mass (Total function only).

The way of sending data and transmission parameters is set using *SErIAL* special function.

If the scale is equipped with two serial joints (interfaces) *Print* and *SERIAL* function is set independently for both interfaces.

If scale cooperates with a computer then the computer must have a special program. Dedicated programs are also offered by AXIS.

Needed drivers and instructions can be found on the CD supplied with Axis scales.

Connecting cable WK-1 (scale – computer / 9-pin interface):

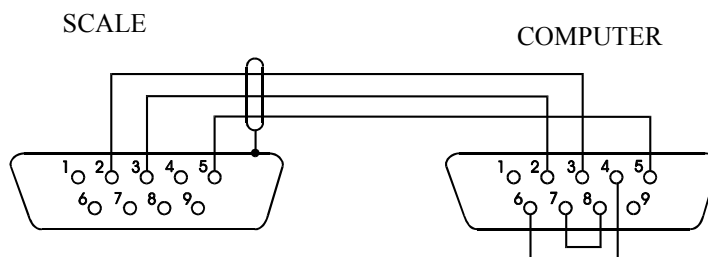

12.1 Detailed LonG protocol description

Standard communication parameters: 8 bits, 1 stop bit, no parity, baud rate 9600bps,

After using  key, measurement data is send together with text description (NET, TARE, GROSS) – all set by using *Print* option. If *Print* isn't set then only scale indication is send (as below).

Data exchange (communication):

- Readout of scale indication

Computer→Scale: **S I** CR LF (53h 49h 0Dh 0Ah),

Scale→Computer: scale response according to description below (16 bytes):

Byte	1	-	sign „-“ or space
Byte	2	-	space
Byte	3÷4	-	digit or space
Byte	5÷9	-	digit, decimal point or space
Byte	10	-	digit
Byte	11	-	space
Byte	12	-	k, l, c, p or space
Byte	13	-	g, b, t, c or %
Byte	14	-	space
Byte	15	-	CR
Byte	16	-	LF

Attention:

Network number different than zero (*SERIAL* / *nr* function) changes scale working mode: communication with a computer is possible after logging the scale in with 02h scale number command. To log the scale out use 03h command.

For example: Using a program to test RS232 interface (program is available in [www.axis.pl / programy komputerowe](http://www.axis.pl/programy_komputerowe)) for scale number 1 please write: \$0201 to log in, then SI, and write: \$03 to close communication.

- Asking about scale presence in system (testing scale connection with computer):
Computer→Scale: S J CR LF (53h 4Ah 0Dh 0Ah),
Scale→Computer: M J CR LF (4Dh 4Ah 0Dh 0Ah),
- Displaying a inscription on scale's display (text communicate from computer):
Computer→Scale: S N n n X X X X X X CR LF, nn-displaying time in seconds; XXXXXX-6 signs to display
Scale→Computer: M N CR LF (4Dh 4Eh 0Dh 0Ah),
- Scale tarring (calling →T← key press) :
Computer→Scale: S T CR LF (53h 54h 0Dh 0Ah),
Scale→Computer: without response,
- Scale zeroing (calling →0← key press):
Computer→ Scale: **S Z** CR LF (53h 5Ah 0Dh 0Ah),
Scale →Computer: without response,
- Scale turning on / off (calling I/⏻ key press):
Computer→ Scale: **S S** CR LF (53h 53h 0Dh 0Ah),
Scale →Computer: without response,
- Entering to special function menu (calling MENU key press):
Computer→ Scale: **S F** CR LF (53h 46h 0Dh 0Ah),
Scale →Computer: without response,
- Setting threshold 1 value (option):
Computer→ Scale: **S L D1...DN** CR LF (53h 4Ch D1...DN 0Dh 0Ah)
D1...DN – threshold value, maximum 8 characters („-” – negative value, digits, dot – decimal separator), number of digits after dot should be the same as on scale display,
Scale →Computer: without response,
Example:
 - in order to set low threshold 1000g in scale B1.5 (d=0.5g) the following order should be sent:
S L 1 0 0 0 . 0 CR LF (53h 4Ch 31h 30h 30h 30h 2Eh 30h 0Dh 0Ah),
 - in order to set low threshold 100kg in scale B150 (d=50g) the following order should be sent:
S L 1 0 0 . 0 0 CR LF (53h 4Ch 31h 30h 30h 2Eh 30h 30h 0Dh 0Ah),,
- Setting threshold 2 value (option):
Computer→ Scale: **S H D1...DN** CR LF (53h 48h D1...DN 0Dh 0Ah),
D1...DN – threshold value, maximum 8 characters
Scale →Computer: without response.
- Setting threshold 3 value (option):
Komputer→Waga: **S M D1...DN** CR LF (53h 4Dh D1...DN 0Dh 0Ah),
gdzie: D1...DN – threshold value, maximum 8 characters
Waga→Komputer: without response.

12.2 Detailed EPL protocol description

Transmission parameters: 8 bits, 1 stop bit, no parity, baud rate 9600bps,

- After using  key in scale:
- Scale→Label printer : set of instruction in EPL-2 language that initialize label printing:

US	- Steering instruction
FR"0001"	- Label number define instruction
?	- Instruction that starts list of variable signs
mm:gg	- 5 signs: minutes:hour
rrrr.mm.dd	- 10 signs: year.month.day
masa	- 10 signs: scale indication+ mass unit
P1	- Steering instruction

Attention:

1. Except variable signs constant signs can also be inscribed e.g. factory name, product name and so on.
2. In standard only one label pattern is possible to printout (number 0001). Using bigger amount of patterns (other label numbers) is possible thanks to *LABEL* special function.
3. To achieve label printout, label printer must have inscribed label pattern (label pattern is created on computer and using computer it is saved to label printer memory). Label pattern is designed by ZEBRA DESIGNER program which is supplied together with label printer.
4. Scales parameters and transmission protocol must correspond to label printer type.

13. Start-up

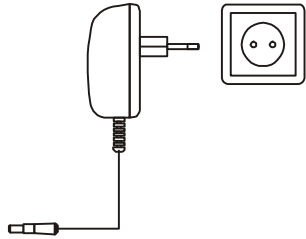

Plug feeder into 230V power supply socket. When the pan is empty plug feeder output connector into 12V socket at back of the balance. Autotests and internal calibration will be performed.

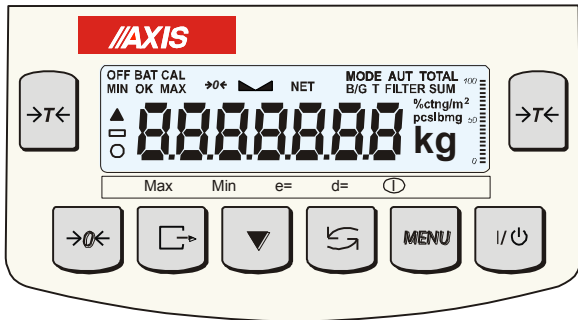

Scale display test (autotests of internal electronic elements C1:8 displayed only when any test result is negative)

Displaying firmware version.

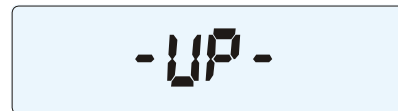

Test of internal calibration.

Internal calibration (in not legally verified balances can be terminated using ▼ key – CAL End communicate confirms).

After zeroing the balance is ready to weighing.

~45 seconds



It is recommended before making measurements to wait until internal temperature of balance stabilize. To accomplish that, the balance should be turned on for more than 2 hours before measurements. From the perspective of measurements accuracy continuous balance operation is beneficial.

14. Weighing with tare



If the scale is not loaded and →0← indicator doesn't indicate, press →0← key.

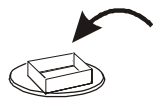

Zero indication and →0← indicator mean that the scale is ready to work.

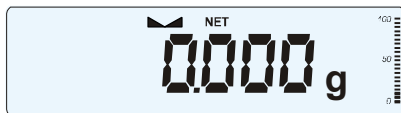

After putting container (package) tare the scale using →T← key. NET indicator will show up.

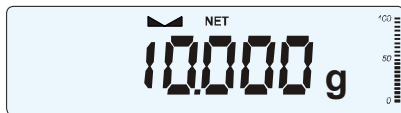
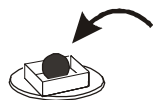

Put on weighted object and readout net weight (NET indicator shows that scale indicates net weight).



In order to readout gross weight press ↺ key (B/G indicator shows that scale indicates gross weight). Press again ↺ key in order to come back to net indications.

15. Scale menu

All scales except for basic metrological functions: weighing and taring, have many special functions and configuration options.

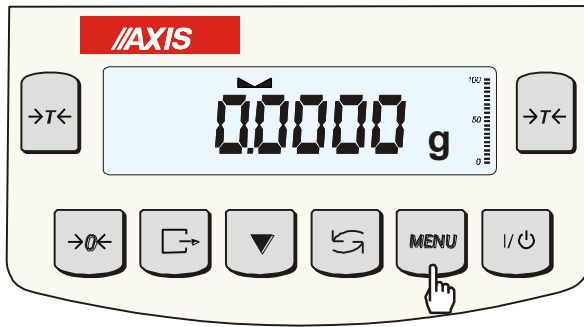

In order to ease using functions user can create his own (personalized) menu.

Creating personalized menu:

In „out of the box” scale after pressing *MENU* key only *SEtUP* option (it contains all configuration options) is available.

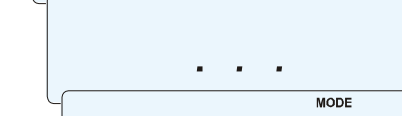
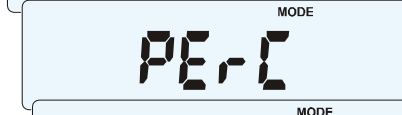
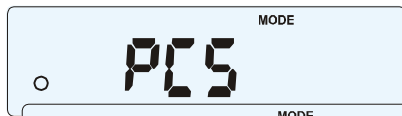
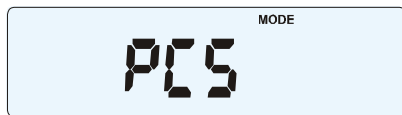
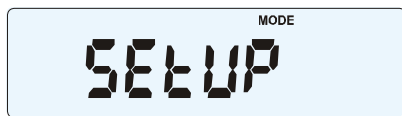

One of the configuration options is *Menu* that is used to create personalized menu.

To add a function to personalized menu press *<T>* key when the function is indicating.

Chosen function is indicated with „o” sign on the left side of display.

After adding all necessary functions press *out* in order to come back to weighing mode. User now after pressing *MENu* key has access to selected earlier functions and to *SEtUP* option. *dEFAULT* option is used to set factory settings.

16. Menu navigation rules

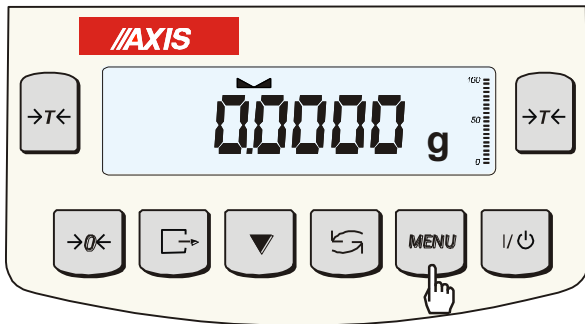

Choosing menu options:

Scale menu shows up after pressing *Menu* key. First menu position is displayed for about 10 seconds. After 10 seconds successive menu positions are displayed automatically.

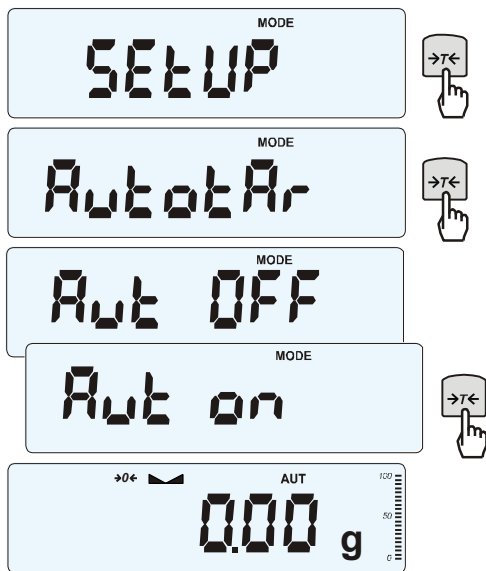

Choosing menu position (option) is done by pressing $\rightarrow T \leftarrow$ key when it is displayed on the screen.

After choosing position (option) usually several options show up:

- on* – turning on selected option,
- OFF* - turning off,
- out* – out to menu.

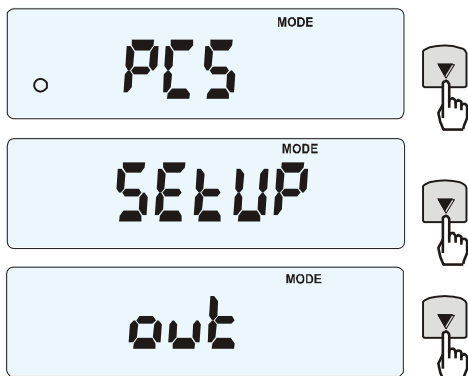

Accelerated working with menu:

First menu position is displayed for about 10s. User can change menu positions manually by pressing \blacktriangledown key.

Immediate out to previous menu level is done by using *Menu* key.

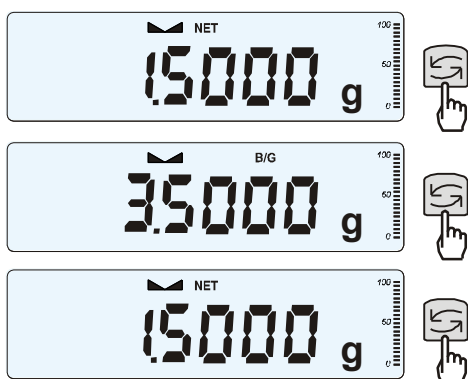

 key working method:

During standard weighing  key is used to switch between net and gross indication.

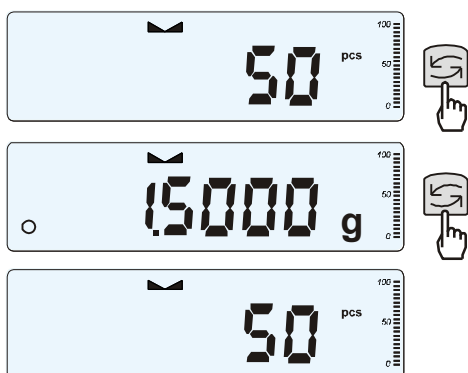

When special function e.g. PCS is turned on, using  key enables to go back to standard weighing mode.

Sign „o” on the left side signalsizes that special function is turned on and user can go back to function mode by pressing  key.

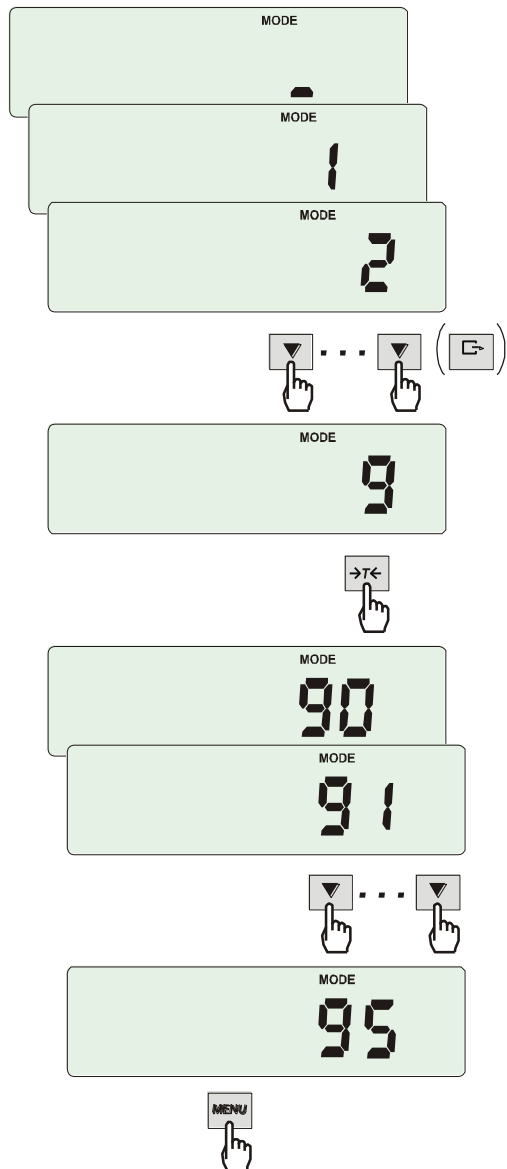

Inscribing numerical values:

Inscribing numerical values is needed in some special functions e.g. *tArE* function requires to inscribe tare values.

Keys:

 - decimal point,
 →T← - next digit position,

 - increasing digit inscribed value (use also →0←),

MENU – end of inscribing.

Menu diagram:

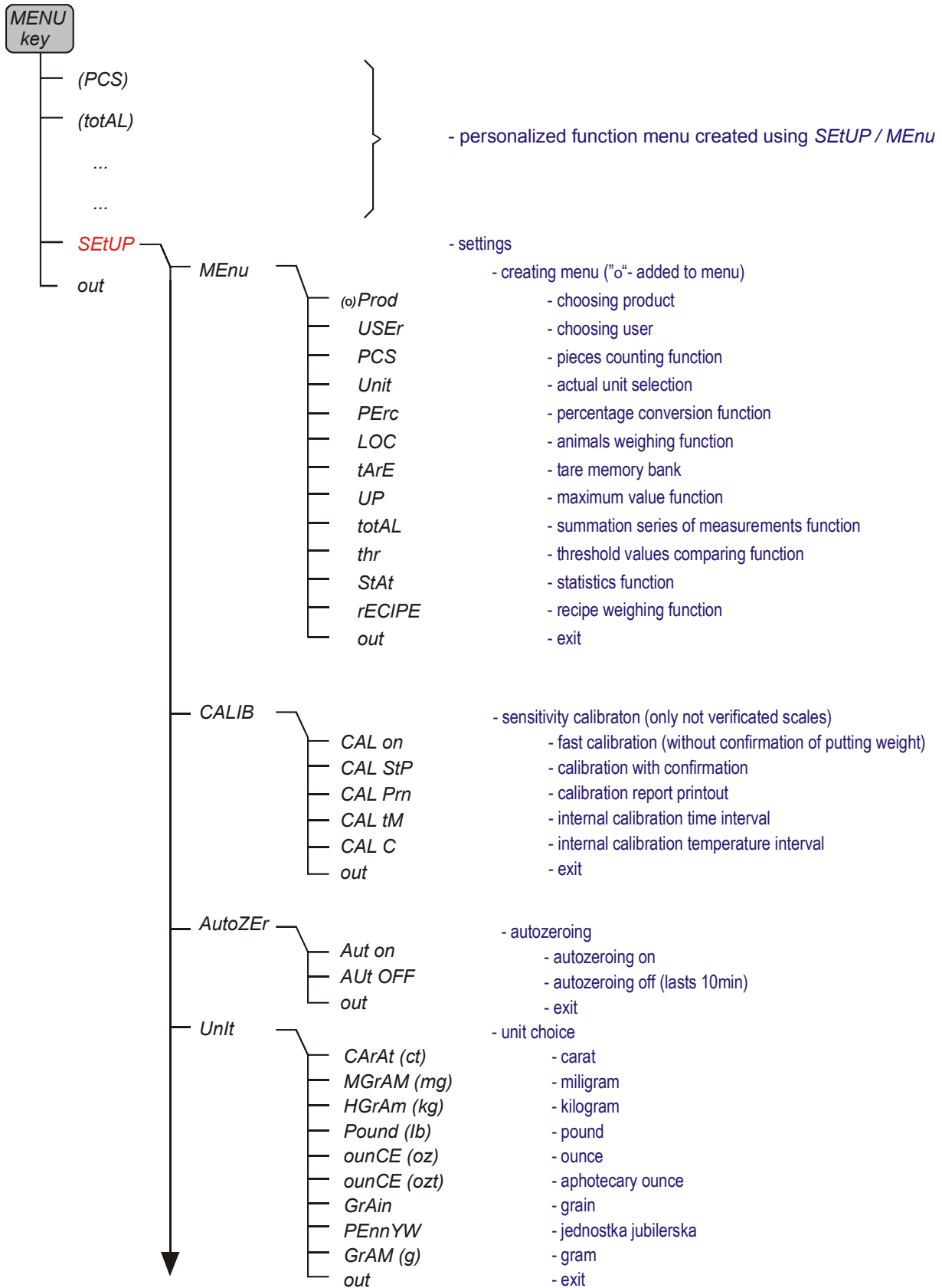

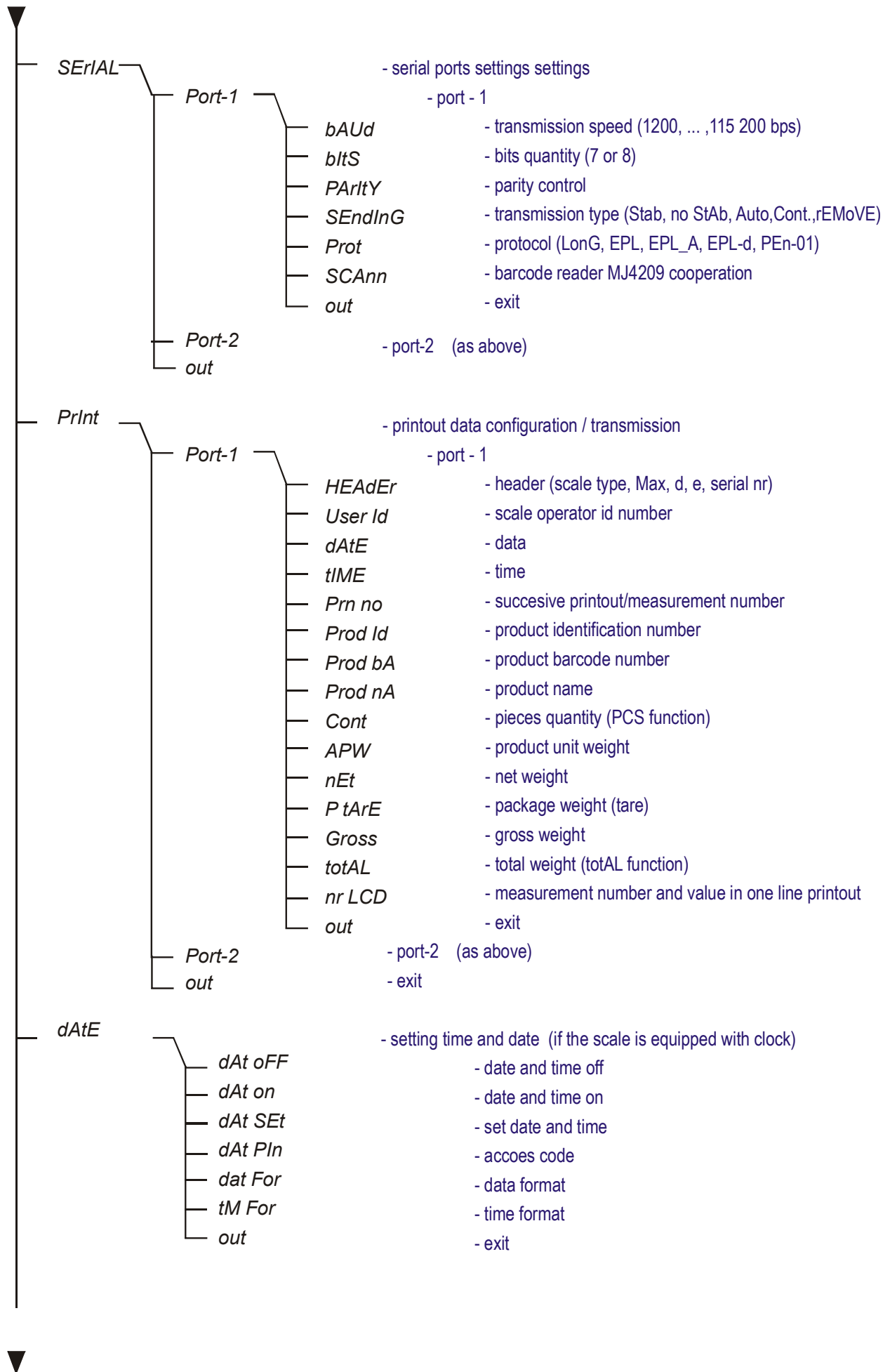

▼		
—	<i>SPEEd</i>	- set weighing speed
—	<i>(bAttEry)</i>	- turn on/off accumulator charging (if the scale is equipped with accumulator)
—	<i>(AUto OFF)</i>	- automatic turning off - saving accumulator power (as above)
—	<i>(ZEro)</i>	- scale start zero inscribing (factory zero)
—	<i>dEFAULT</i>	- restore default settings for all options
—	<i>SErVICE</i>	- options only for service
—	<i>out</i>	- exit

17. Scale setup (SEtUP)

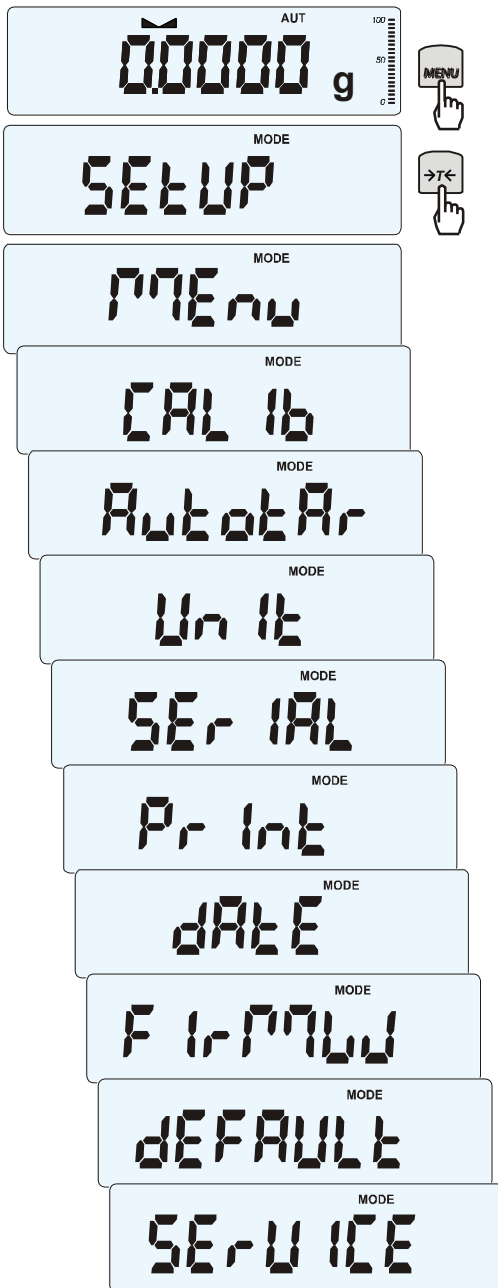

SEtUP contains all options used for setting scale work mode:

- ❑ *MEnu* – creating personalized user menu,
- ❑ *CAL Ib* – scale sensitivity calibration,
- ❑ *AutoZEr(ing)* – self-maintaining zero indication (unloaded scale),
- ❑ *UnIt* – weight unit selection,
- ❑ *SErIAL* – setting serial ports,
- ❑ *PrInt* – transmission (printout) data selection,
- ❑ *dAtE* – inscribing actual date and time,
- ❑ *FirMW(are)* – uploading new firmware (only for service)
- ❑ *dEFAULT* – reset to factory settings,
- ❑ *SErVICE* – service menu (only for service).

17.1 Scale calibration (CAL**I**b)

Calibration with external weight should be performed if balance accuracy after internal calibration is not satisfactory. Calibration weight stated in technical data table for the balance (or of better accuracy) with valid verification certificate should be used then.



Calibration of legally verified balance requires violating a mark used to protect an access to adjustment switch and results in losing legal verification. To renew legal verification of the balance, it is necessary to contact a service or notified body.

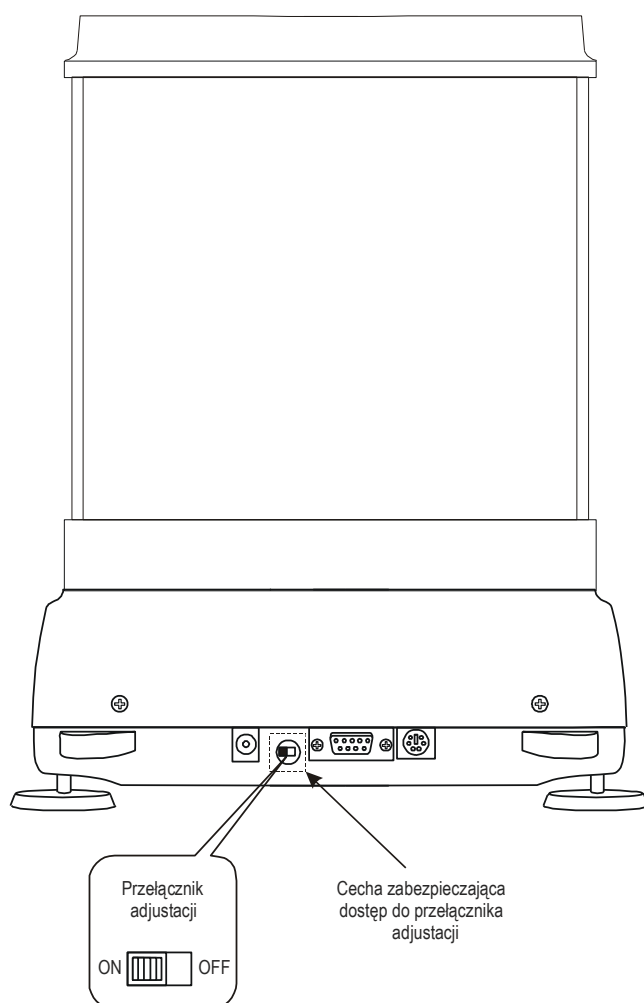

In balances comply with verification requirements performing calibration requires changing adjustment switch position, which is placed behind protecting mark (sticker) of a notified body. An access to the mark is possible only after removing the mark.

Before proceeding with calibration for balances comply with verification requirements, adjustment switch should be set to *ON* position using thin screwdriver (the balance will display the message *Pr ON*). When calibration process, described on next page, is finished, the balance will display the message *Pr ON*. Adjustment switch should be set to *OFF* position using thin screwdriver (the balance will move to weighing).

Calibration with external weight:

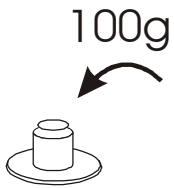

Press *MENU* key.



Press $\rightarrow T \leftarrow$ key when *CALib* function appears.



The following options will be displayed:

- *CAL on* – calibration with external recommended standard of mass (see technical data).
- *CAL StP* – calibration with external weight, confirmation of successive steps - *MENU* key, *out* – leave without changes
- *CAL Prn* – calibration report,
- *CAL tM* – set time interval for internal calibration,
- *CAL °C* – set temperature difference for internal calibration,
- *out*.

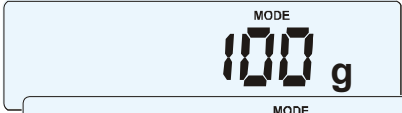
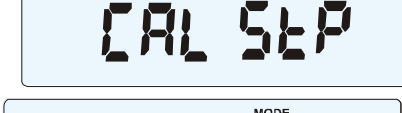

Press $\rightarrow T \leftarrow$ key when *CAL StP* option appears (calibration in two steps).

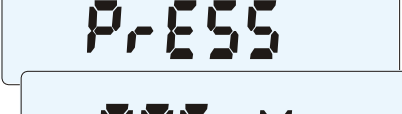

Press $\rightarrow T \leftarrow$ key when weight value used for calibration is indicating or use *othEr* option and inscribe proper value (keys $\rightarrow 0 \leftarrow$, $\rightarrow \leftarrow$, $\rightarrow T \leftarrow$)

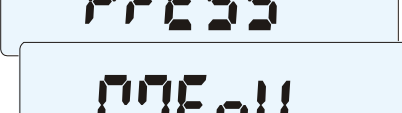
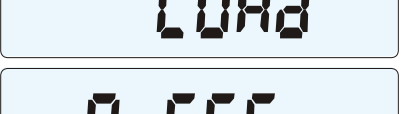
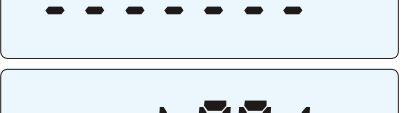

Press *MENU* and wait for writing zero to the scale.

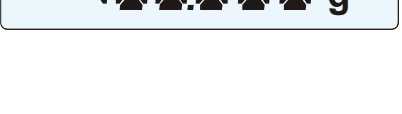

When *LOAD* message appears put standard of mass on the pan. Press *MENU* key (*CAL on* doesn't need pressing *MENU* key).

Wait until internal calibration is finished and zero indication is displayed.

Internal calibration options (only AKA):

Internal calibration of the balance is performed automatically every time the balance is switched on, additionally after given time interval during work and after every temperature change of more than given value.

In order to perform internal calibration in any moment, empty the pan and press  key twice (one more pressing terminates calibration).

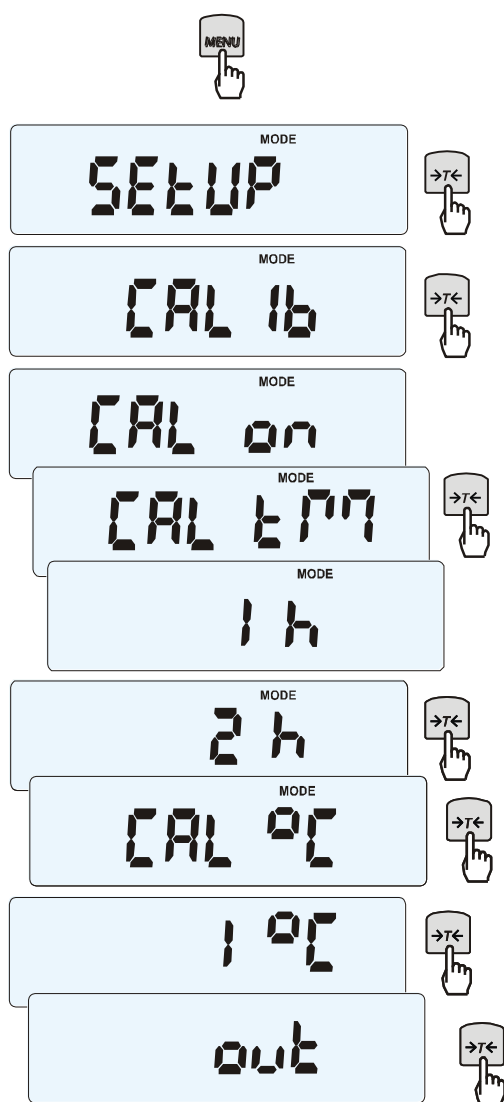

Press *MENU* key to display function menu and choose *CAL Ib* function by pressing $\rightarrow T \leftarrow$ key when it is displayed.

The following options will appear:

- *CAL on* – perform calibration with external weight
- *CAL Prn* – printout of calibration report
- *CAL tM* – set time interval for internal calibration (1h – 6h)
- *CAL °C* – set temperature difference for internal calibration (1°C - 4°C)
- *out* – switch internal calibration off for internal calibration

Press $\rightarrow T \leftarrow$ key when *CAL tM* option is displayed. Predefined time intervals for internal calibration will be displayed. Select required value pressing $\rightarrow T \leftarrow$ key.

Accordingly choose *CAL °C* option pressing $\rightarrow T \leftarrow$ key and selecting values of temperature difference.

Select *out* option to finish.

The form of AKA balance calibration report printout (option CAL Prn):

```
----- CALIBRATION REPORT -----  
  
AKA220 MAX=220g e=0.01g d=0.001g  
S/N   : 1234  
PROD.DATE: 2014-12-16  
FIRM.VER.: AKA_01 2015-01-12 AKA106  
  
FACTORY EXT.LOAD : 200.00 g  
FACTORY INT.LOAD : 196.131 g  
CALIBRATION NO. : 1  
CALIBRATION DATE : 2015-01-22  
CALIBRATION TEMP1: 30.346 °C  
CURRENT EXT.LOAD : 200.00 g  
CURRENT INT.LOAD : 196.131 g  
WEIGHT DIFFERENCE: 0.00 g
```

17.2 Autozeroing function (AutotAr)

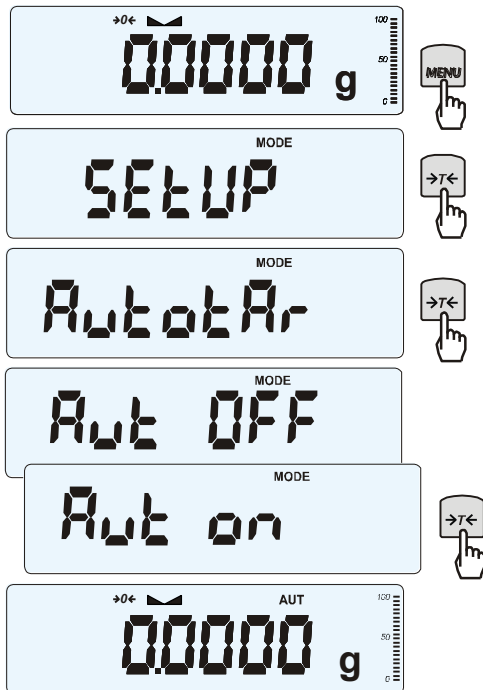

When the function is activated, the scale automatically ensures stable zero indication if the pan is empty or if zero indication was acquired by pressing $\rightarrow T \leftarrow$ key.

To turn on the function use *MENU* key and using $\rightarrow T \leftarrow$ key choose *AutotAr* and then *Aut on*

To leave the function press *MENU* key, then choose *AutotAr* and *Aut OFF*.

Note:

1. *Aut* sign occurs only in scales with LCD display.
2. In scales with active $\rightarrow 0 \leftarrow$ key function changes name into *AutoZE* (autozeroing) and works only when the scales is unbiased.

17.3 Weight unit selection (Unlt)

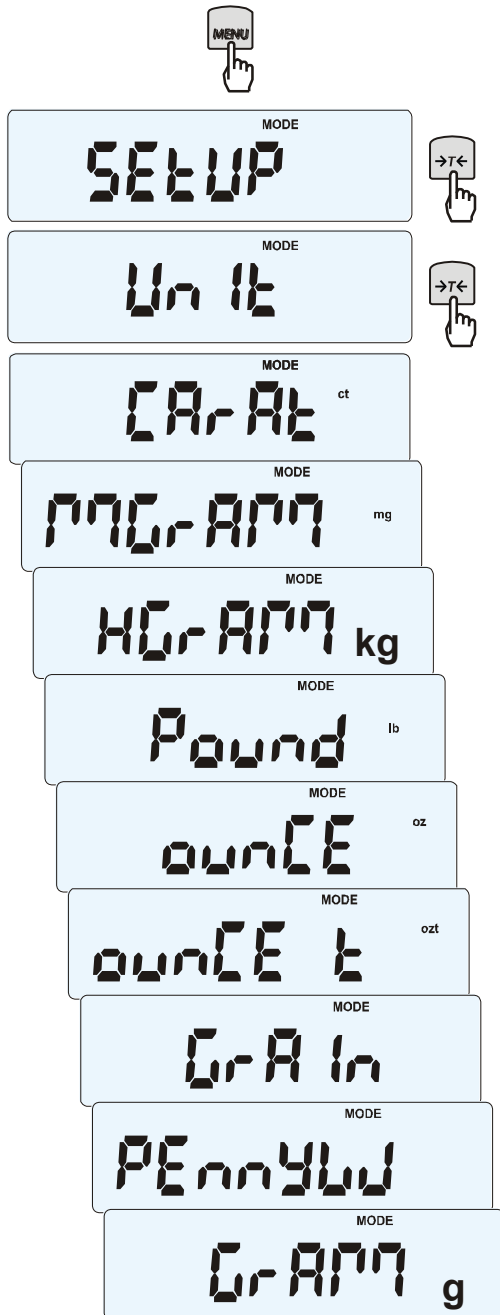

- The function allows selecting weighing unit:
- CarAt (1 ct= 0,2 g) - carat,
 - MGrAM (1mg=0,001g) milligram,
 - KGrAM (1kg=1000g) kilogram,
 - Pound (1 lb=453,592374g) English pound,
 - OunCE (1oz=28,349523g) - ounce,
 - OunCEt(1ozt=31,1034763g) pharmaceutical ounce,
 - GrAIn (1gr=0,06479891g) - grain
 - PennYW (1dwt=1,55517384g) jewellery mass unit,
 - GrAM (1g) - gram.

The way of choosing carats as weighing unit is shown on the example.



Readout for different units:

Unit	Readout
g	0,0001 g
ct	0,0005 ct
kg	000 0001 kg
mg	0,1 mg
lb	000 0001 lb
oz	0,000 001 oz
ozt	0,000 001 ozt
gr	0,001 gr
dwt	0,0001 dwt

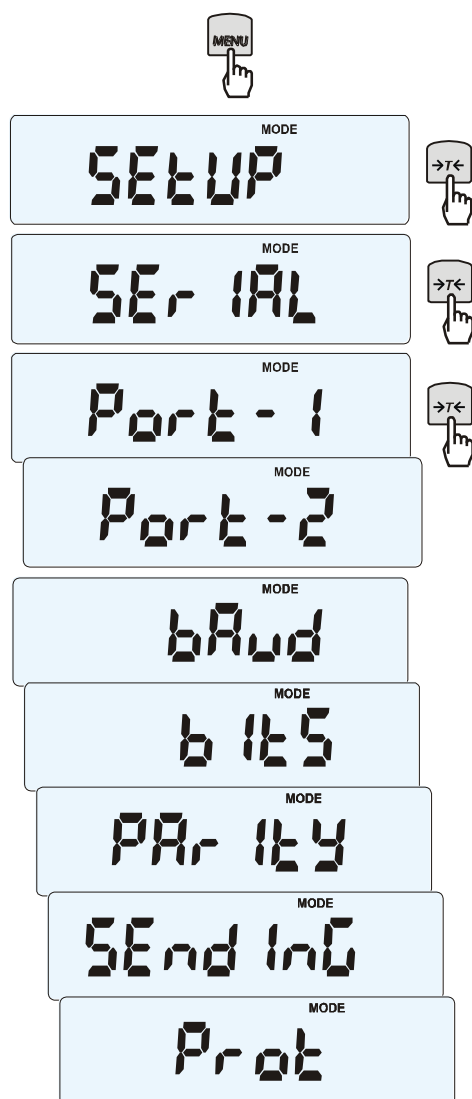
17.4 Serial port parameters setting (SErIAL)



The function allows setting independently communication parameters of both of serial ports *Port-1* and *Port-2* (executed in RS232C, RS485, USB or LAN standard):

- transfer protocol (*Prot*):
 - LonG* – cooperation with printer or computer,
 - EPL* – cooperation with label printer in normal mode (activates *LABEL* function),
 - EPL_A* – cooperation with label printer in automatic mode (activates *LABEL* function),
 - EPL_d* – cooperation with special label printers,
 - Pen-01* – cooperation with PEN-01,
 - baud rate (*bAud*): (4800, 9600, ... 115 200bps),
 - number of bits in single char. (*bitS*): 7, 8,
 - parity control (*PARitY*):
 - nonE* – no control
 - Odd* – nonparity
 - Even* – parity control,
 - scale number in network (*nr*):
 - (if the scale doesn't work in network the number must be 0),
 - transmission through serial interface (*SEndInG*):
 - StAb* – transmission after  key is used and result is stable,
 - noStAb* – transmission after  key is pressed without need of stabilisation,
 - Auto* - automatic transmission after load is put on and result is stable (*Auto*),
 - Cont* - continuous transmission, about 10 results per second (*Cont.*),
 - Remove* - trans
- Default parameter values:
Long, 9600 bps, 8 bits, none, *StAb*,
- *SCAnn* – cooperation with MJ-4209 barcode readers.

In order to set needed parameters choose *SErIAL* function, select appropriate parameter and press $\rightarrow T \leftarrow$ key when required option or parameter value is displayed.

In scales with an additional serial port appear *Port-1* and *Port-2*, for the independent setting of both ports.

17.5 Printout configuration (Print)

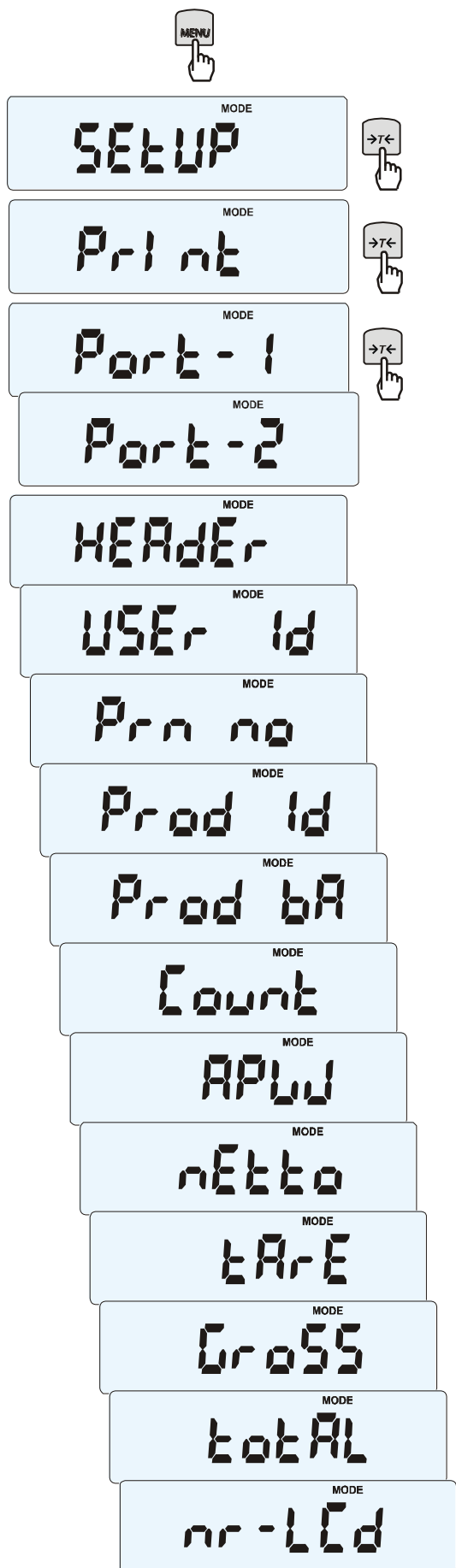

Function is used for printing additional information stored in scale memory, weighed product identification data and scale operator id. That information is inscribed using scale keys or scanner.

The function allows to switch on/off following positions on the printout:

- *HEAdEr* – header: name, model and scale number,
- *USEr Id* – scale user identification number,
- *USEr nA* – user name,
- *Prn no* – successive printout number (choose this option to zero counter),
- *Prod Id* – product number,
- *Prod bA* – product barcode (inscribed or scanned),
- *Prod nA* – product name,
- *Count* – counting result (PCS function),
- *APW* – unitary mass (PCS function),
- *nEt* – net mass
- *tArE* – current tare value,
- *GroSS* – gross mass,
- *totAL* – total mass (*totAL* function)
- *nr* – LCD – printout number and indication in one line

Attention:

If *Prod Id* or *USEr Id* is chosen, it is possible to inscribe quickly their new values (with omission of main menu).

In order to do that hold (about 3 seconds) *MENU* key and release it when *Prod Id* or *USEr Id* indicates. Inscribe new value using keys:

- 0← - increasing digit,
-  - decimal point,
- T← - next digit,
- MENU* - end.

While inscribing *Prod id* user can use barcode reader connected to RS232C interface.

If the scale is equipped with two serial joints *Print* function is set independently for both interfaces.

Sample printout during normal weighing (all printout positions deactivated):

```
20.07 kg
20.04 kg
20.04 kg
```

Sample printout during normal weighing with clock option (all printout positions deactivated):

```
20.07 kg 2012-11-08 10:01
20.04 kg 2012-11-08 10:01
20.04 kg 2012-11-08 10:01
```

Sample printout during normal weighing (some printout positions activated):

```
AKA220
MAX: 220g e=0.01g d=0.001g
S/N :

USER ID.      : 000001
DATE          : 2012-11-08
TIME          : 12:26
NO            :      3
PROD ID       : 01
COUNT        : 0 PCS
APW           : 0.0000 g
NET           : 213.8 g
TARE          : 0.0000 g
GROSS : 213.8 g
TOTAL         : 0.0000 g
```

17.6 Weighing speed selection (*SPEED*)

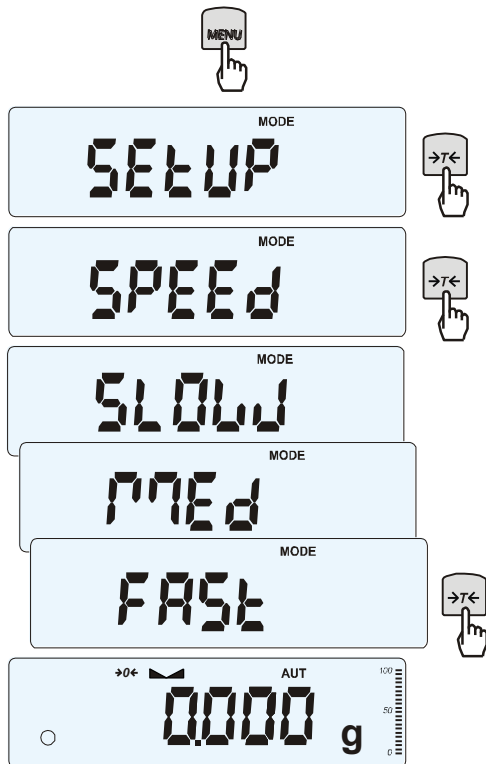

Option enables to change weighing speed, that enables better performance thanks to adaptation to environment conditions.

To turn on the function use *MENU* key and choose *SPEED* option by using *→T←* key, then select one of these options:

- *SLOW* – slow measurement,
- *MEd* – medium,
- *FAST* – fast,
- *DEFAULT* – back to factory setting.

Attention:

When setting fast speed check if weighing results are stable. Otherwise use slower option.

17.7 Analog out configuration (AnALOG) – option



Option enables to set analog out (4-20mA or 0-10V) working mode used eg. for PLC controllers:

- *AnG rAnG* – inscribing range value (Max)
- *AnG CFG* – out configuration (*PLUS* – work only with positive values, *MinuS* – work only with negative values, *both* – work with positive and negative values).

18. Special functions description

All scales besides basic metrological functions: weighing and taring, have a set of special functions. Depending on meter type functions set differs. Below a list of functions available in standard ME-01 type meters:

- ❑ Add id number to product (*Prod*),
- ❑ Add id number to user (*USER*),
- ❑ pieces counting function (*PCS*),
- ❑ change of mass unit (*Unit*),
- ❑ percentage weighing function (*PERC*),
- ❑ selecting label number function (*LABEL*),
- ❑ weighing large animals function (*LOC*),
- ❑ entering tare function (*tArE*),
- ❑ maximum value indication function (*UP*)
- ❑ summing series of measurements (*totAL*)
- ❑ statistical calculations (*StAt*)
- ❑ recipe making (*rECIPE*)
- ❑ density measurement (*dEnSIty*)

and functions that require additional equipment to be completely functional:

- options with the clock:
 - setting current date and time function (*dAtE*)
 - total weight function (*totAL*)
- options with the transoptors connectors (*WY Γ*):
 - checkweighing function (*thr*)

LabEL function is available in scales with EPL or EPL-A transmission protocol activates (go to *SetuP/SERIAL*).

18.1 Product and user identification (Prod and USEr)

The balance enables to inscribe product barcode and user identification number:

- *Prod bA* – product barcode,
- *USEr Id* – user identification number.

Balance product barcode and user readout together with external devices (e.g. printer, label printer and computer) enables to build simple identification and archivisation systems.

Inscribing multi-digit data without using e.g. computer keyboard is inconvenient and using barcode reader is beneficial.

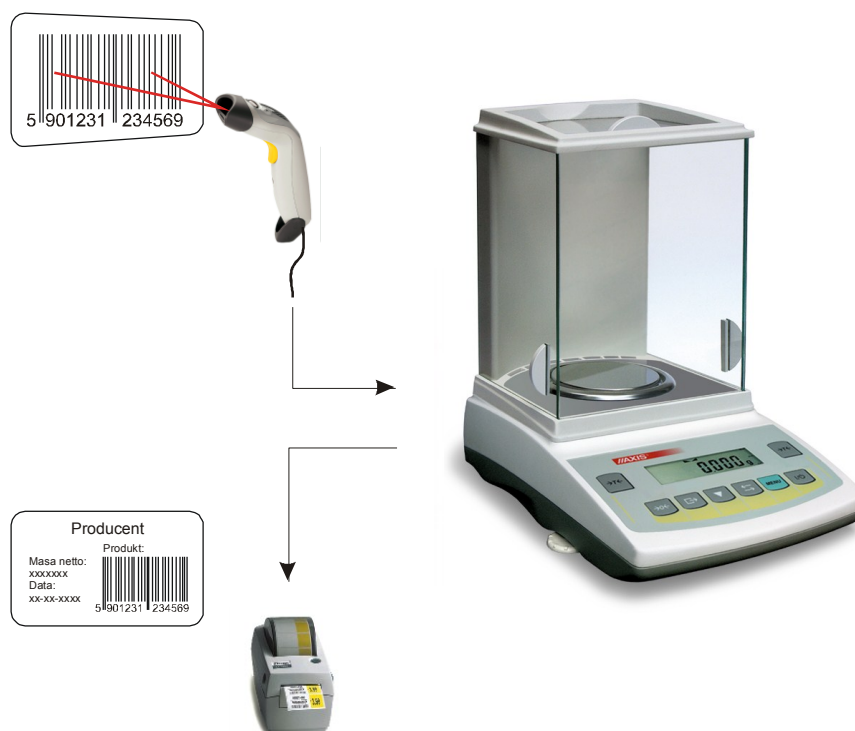

After selecting product and user it is possible to send (to computer or printer) actual scale indication with additional data, selected by *Prnt* option (*SetuP*):

- *HEAdEr* – header: name, model and scale number,
- *USEr Id* – scale user identification number,
- *USEr nA* – user name,
- *Prn no* – successive printout number (choose this option to zero counter),
- *Prod Id* – product number,
- *Prod bA* – product barcode (inscribed or scanned),
- *Prod nA* – product name,
- *Count* – counting result (PCS function),
- *APW* – unitary mass (PCS function),
- *nEt* – net mass
- *tArE* – current tare value,
- *GroSS* – gross mass,
- *totAL* – total mass (*totAL* function)
- *nr* – LCD – printout number and indication in one line

Inscribing data to base

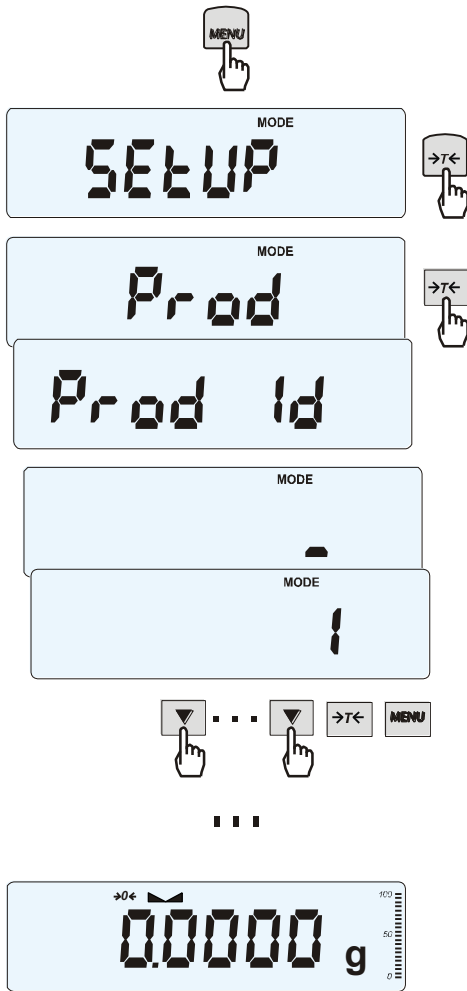

Prod and *USER* options enables inscribing single product and user data.

To inscribe data use keys:

- ▼ - increasing digit,
- T← - next dixit,
- MENU – end of inscribing.

Barcode reader (connected to RS232C interface) can also be used to inscribe data and this way it is faster and more effective.

18.2 Pieces counting function (PCS)

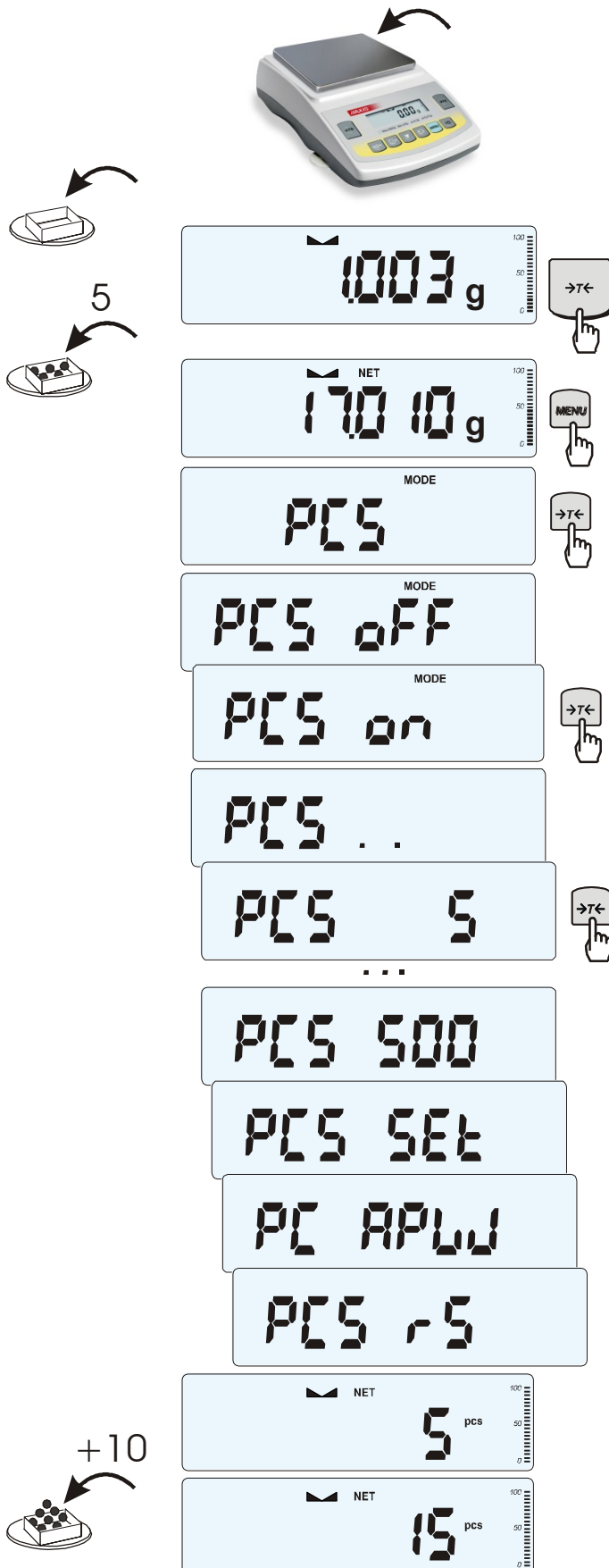

This function enables to count identical pieces, e.g. turnbuckles or buttons.

A measurement is performed in two phases:

- first phase - single piece weight calculation on the basis of defined pieces amount (5, 10, 20, 50, 100, 200 or 500 pieces),
- second phase – pieces counting.

First phase options:

- *PCS ..* – recalling of a value inserted earlier (this quantity must be inscribed earlier),
- *PCS SET* – set any amount of pieces in a sample,
- *PCS APW* – set unitary mass directly,
- *PCS rS* – inserting number of details in a sample and receiving of their mass from other scale connected by RS-232C.

It is advised that single piece weight is not less than one reading unit and sample weight used in first phase is bigger than 100 reading units.

To leave function press *MENU* key and then using *→T←* key chose *PCS* and *PCS OFF*.

Note:

1. *APW too LOW* communicate signalises that a sample was not put on the pan or if single piece weight is less than one-tenth readout plot (counting is not possible).
2. *APW LOW* communicate signalizes that single piece weight is more than one-tenth but less than one readout plot. (counting possible but with bigger errors, result blinks).
3. In scales equipped with LED display pcs sign is replaced with “■”.

18.3 Percentage weighing function (PErC)

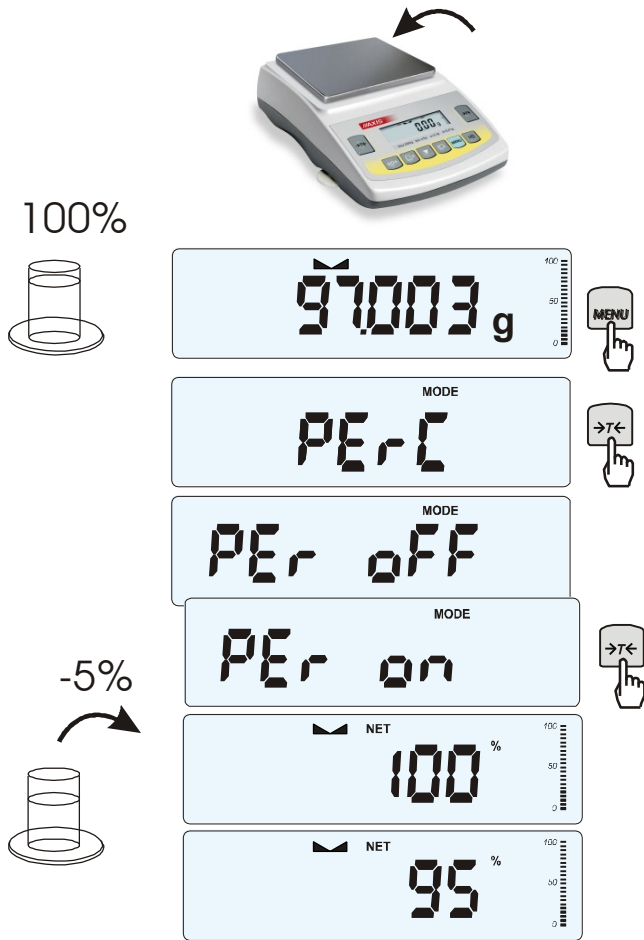

This function allows displaying weighing result in percents.

A measurement is performed in two phases:

- first phase – weighing a reference sample (100%),
- second phase – measuring specific sample as a percentage of the reference sample.

Weighing result is displayed in different format, depending on the weight value of reference sample.

The function has the following options:

- *PEr off* – disable the function,
- *PEr on* – set current scale indication as 100% and activate percentage weighing,
- *out* – exit without changing settings.

Note:

1. *PEr Err* message informs that reference 100% mass is less than $0,5 \cdot \text{Min}$ or was not defined.
2. In scales with LCD display sign "■" is replaced with %.

18.4 Label choosing function (LAbEL)

This function is used in scale with *ELTRON* (*SErIAL* function) data protocol. This protocol enables label printout with actual scale indication and chosen data from *PrInt* special function (variable data), for example date and time. Other data, for example company address, product name, barcode can appear on label as a constant text. Label patterns with number (4 digit) used by user should be saved in scale memory according to printer manual. Label pattern choice is made by inscribing label number using *LAbEL* function.

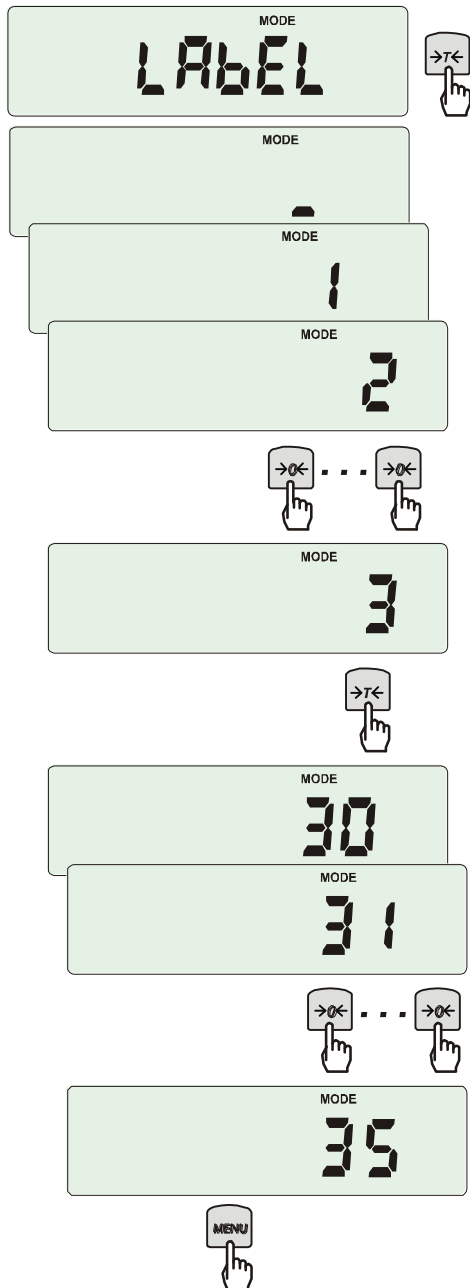

Press *MENU* button.

When *LAbEL* is displayed press $\rightarrow T \leftarrow$ key. Actual label number will show.

To enter new label number press $\rightarrow T \leftarrow$ key, to exit function without number change press *MENU*.

To inscribe label number use keys:

- ▼ - digit increase,
- $\rightarrow T \leftarrow$ - next digit,
- MENU* - end.

After entering label number, putting load and pressing  key will cause sending data to label printer.

Data format sent to label printer (label nr 1, language EPL-2):

US	(55 53 0D 0A)
FR"0001"	(46 52 22 30 30 30 31 22 0D 0A)
?	(3F 0D 0A)
00:00	(30 30 3A 30 30 0D 0A)
2000.00.00	(32 30 30 30 2E 30 30 2E 30 30 0D 0A)
10 g	(20 20 20 20 20 31 30 20 20 67 0D 0A)
P1	(50 31 0D 0A)

18.5 Weighing animals function (LOC)

The function allows weighing animal moving on the scale.

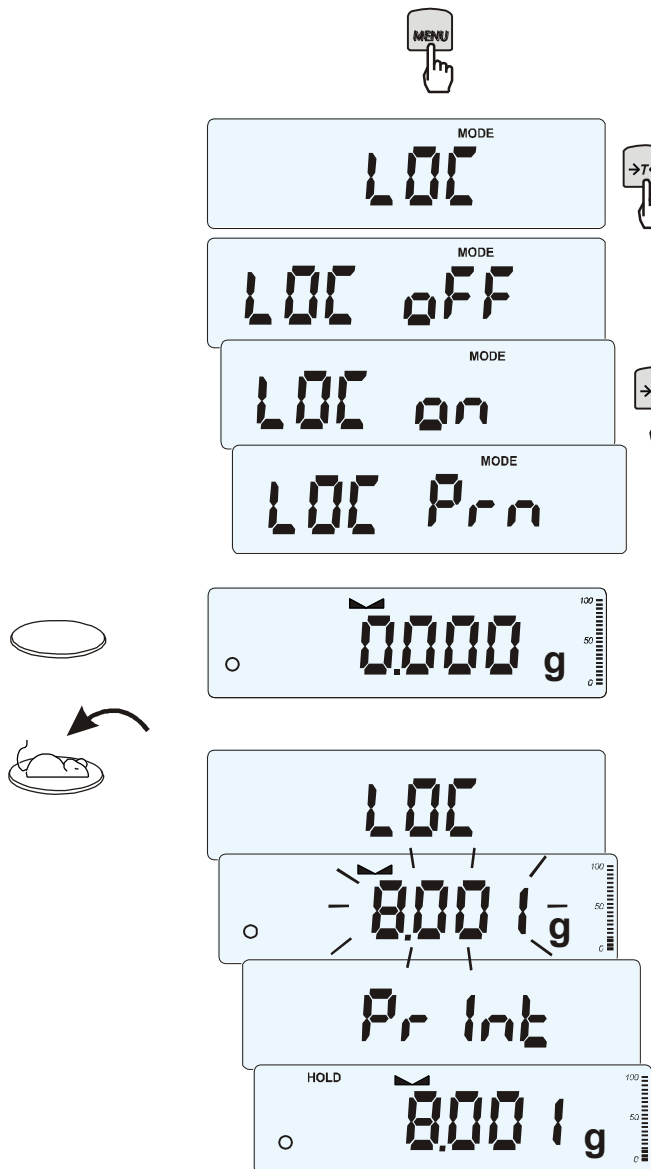

Press *MENU* key.



When *LOC* function is displayed press $\rightarrow T \leftarrow$ key. The following options appear on display successively:

- *LOC off* – leave the function,
- *LOC on* – automatic weighing after loading the scale,
- *LOC Prn* – the measurement initiated manually by pressing $\rightarrow T \leftarrow$ key.



When *LOC on* is displayed press $\rightarrow T \leftarrow$ key.

Tare the scale using $\rightarrow T \leftarrow$ key if necessary and place the animal on the pan.

Wait until the weighing result is averaged – scale display blinks. Then scale will show stable (averaged) result and will send it through serial port.

The result remains on display for about 30 second.

Important notes:

1. The loads lower than Min value are not averaged.
2. In case when putting animal on scale takes more than 5s it is suggested to choose *LOC PRN* option (measurement started manually by pressing $\rightarrow T \leftarrow$ key).

18.6 Constant tare memory function (tArE)

This function enables to measure gross weight of a sample placed in a container of a known weight value (stored in the memory) and to display calculated net weight of the sample. Tare value is recalled from the memory with $\rightarrow 0 \leftarrow$ or $\rightarrow T \leftarrow$ key when the pan is empty. Tare value may be entered using keypad or by putting container on the pan.

Inscribing tare value to memory:



After pressing *MENU* key and choosing *tArE* function using $\rightarrow T \leftarrow$ key, the following options are available:

- *tAr OFF* – leave the function,
- *tAr on* – activate the function with the previous tare value,
- *tAr ..* – sample tare value from the pan,
- *tAr SET* – enter tare value with keys: $\rightarrow 0 \leftarrow$, $\rightarrow T \leftarrow$ and *MENU*
- *out* – printout a setting value of tare.

Press $\rightarrow T \leftarrow$ key when *tAr SET* is displayed.

By pressing $\rightarrow T \leftarrow$ key choose proper memory cell where tare will be stored: *tAr 01, 02, ... , 10*.

Choose inscribing method :

- *MANUAL* – inscribing using keys: $\rightarrow 0 \leftarrow$, $\rightarrow T \leftarrow$ and *MENU*,
- *Pan* – inscribing mass value that is on the pan.

After storing tare, the scale starts working with inscribed tare value.

Note:

Tare value is stored in memory also after unplugging the scale from the mains.

Weighing with constant tare:

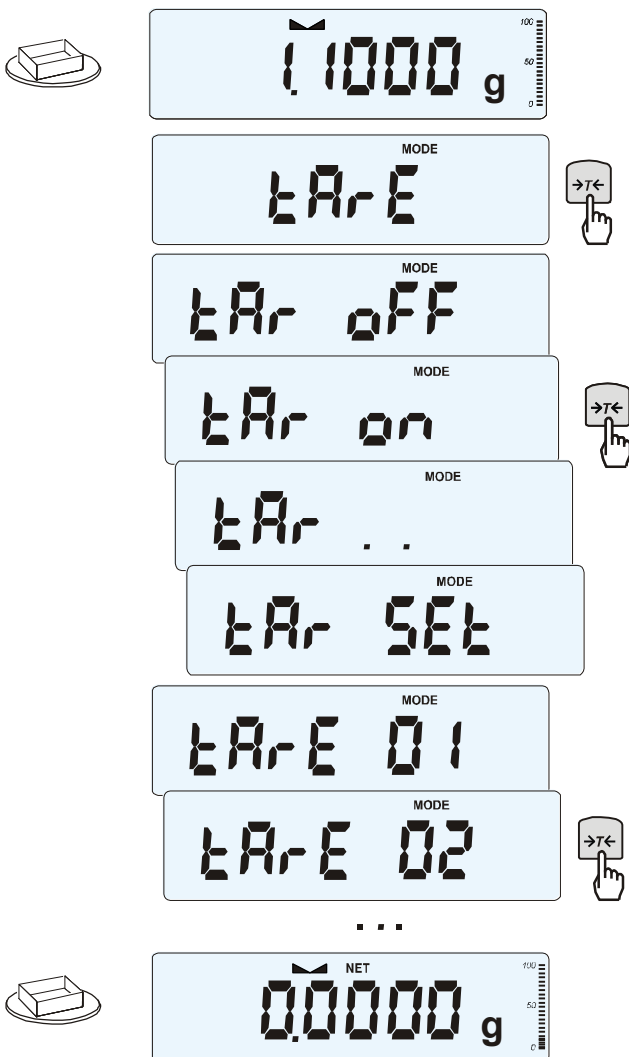

In order to use tare value that is located in memory, choose from menu *tArE* function and then *tAr on* option.

A list of memory cells will show up:

tAr 01, 02, ... , 10.

Cells with inscribed value are marked with "o" sign on the left side, active value marked with "▲".

ATTENTION: In scales with LED display, cells with inscribed value are marked with "■".

Choose proper memory cell using $\rightarrow T \leftarrow$ key.

tArE function is activated with chosen tare value. Moreover the scale will indicate nett weight (weight on the pan minus tare values). Using $\rightarrow T \leftarrow$ key (or $\rightarrow 0 \leftarrow$, while empty pan) causes scale zeroing and then subtraction of recalled tare. Minus indication will show up.

18.7 Maximum value indication function (UP)

This function allows holding maximum (or minimum) value that is indicating at the moment.

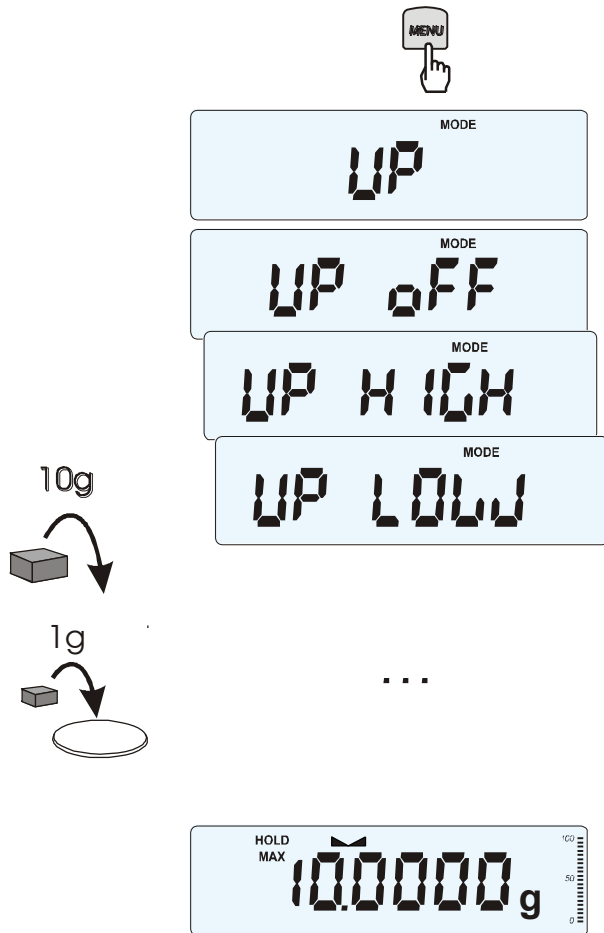

Before measurement scale should be tared.

Function has following options:

-UP OFF – function off,

-HIGH – holding maximum value,

-LOW – holding minimum value.

Pressing →T← key will cause result zeroing.

Note:

Autozeroing function and the stabilisation indicator are deactivated when UP function is running.

18.8 Total weight function (totAL)

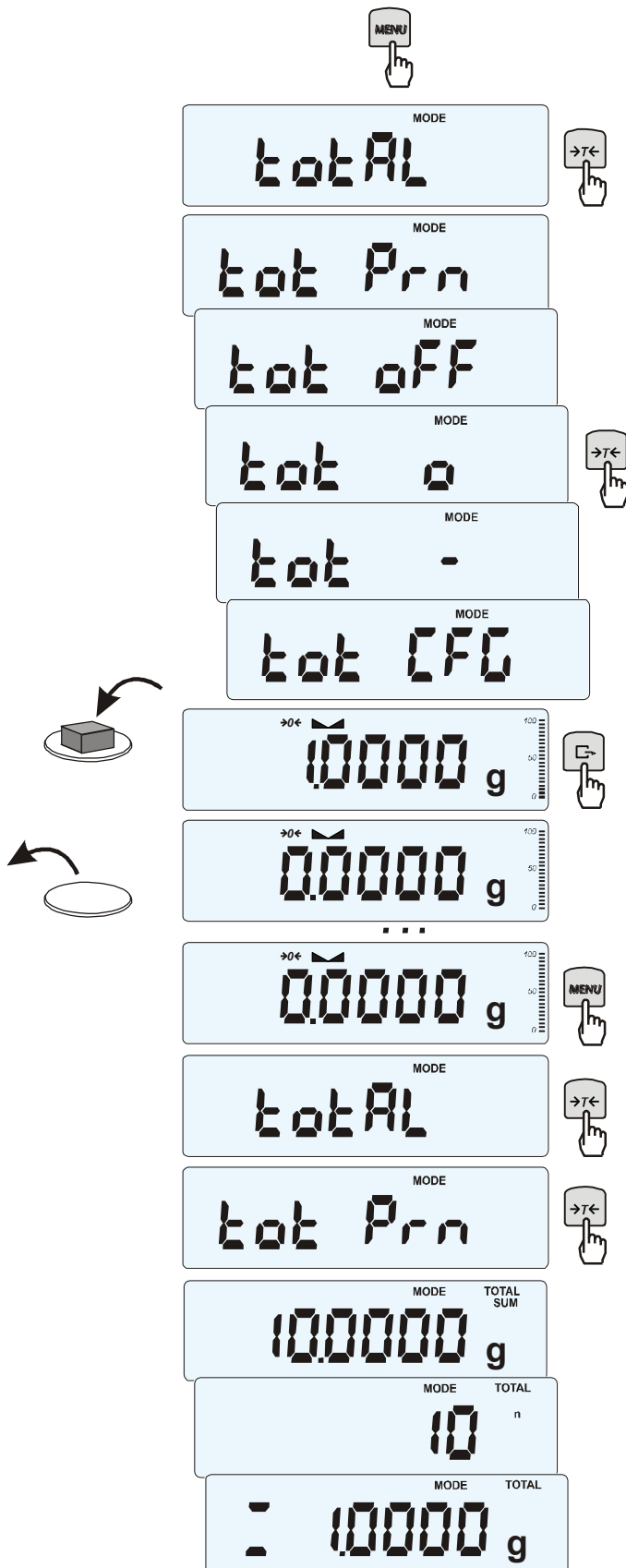

The function allows calculating total weight for series of measurements, which can be greater than scale capacity. It allows calculating total weight as well as average value.

Press *MENU* key.

When *totAL* is displayed press $\rightarrow T \leftarrow$ key.

The following options will appear successively:

- *tot Prn* - report printout without clearing total register,
- *tot OFF* - clearing total register, report printout and leaving the function,
- *tot 0* - working with receipt printout after each measurement,
- *tot -* - working without receipt printout,
- *tot CFG* - saving measurement mode (using \leftarrow key: *Manual*, after taking off the load : *auto*).

Press $\rightarrow T \leftarrow$ key when *tot 0* is displayed.

Perform measurement series by pressing \leftarrow key for storing results into total register.

In order to print and display results enter the function by choosing *totAL* and *tot Prn* option from menu.

The results are displayed in the following sequence:

- total weight (SUM \equiv),
 - number of registered measurements (n),
 - average value (\equiv),
- regarding that moving to display successive result is performed after pressing \leftarrow key.

Attention: In scales with LED display SUM sign is replaced by " \equiv ".

In order to go back to total weighing without zeroing total register press \leftarrow key several times.

To leave the function with clearing total register, select *totAL* function from menu and choose *tot oFF* option. Scale prints the communicate informing about clearing registers.

The form of receipt after each measurement:

Date: ...	Time. ...
measurement no	weight
measurement no	weight

Report form:

Date: ...	Time. ...
TOTAL WEIGHT	=
NUMBER OF SAMPLES	=
AVERAGE VALUE	=

Note:

When the scale doesn't have an internal clock, Date and Time do not appear on printout.

Maximum number of measurements is 99 999.

Maximum total load 99 999 000d.

The weighing unit of the total value from the register (Total) is the same as the weighing unit stated on the keypad or is 1000 times greater, what is signalled by "o" indicator at the left of the display.

If the registered value is too big to be displayed, "E" communicate appears on the display. If the number of series is too high and cannot be displayed, "Err1" communicate appears on the display

18.9 Checkweighing function (*thr*)

This function allows comparing weighing result with two programmed reference values: lower and upper threshold. Comparison result is signalled with indicators (MIN, OK, MAX) and sound signal generated when threshold values are exceeded.

If comparison result is:

- smaller than zero threshold – no signal,
- smaller than lower threshold – the scale signals MIN (yellow colour),
- between threshold values - the scale signals OK (green colour, with the short sound signal),
- greater than upper threshold - the scale signals MAX (red colour, long sound signal).

The checkweighing results can be use to control:

- optical indicator (*Indication mode*),
- batching devices (*Batching mode*).

Standard scale is set for cooperation with optical indicator.

On outputs P1-P3 (*Relays socket*) short-circuit states appear as result of comparison scale indication with threshold values.

On the chart below output states are shown during increasing load on the scale for both working modes:

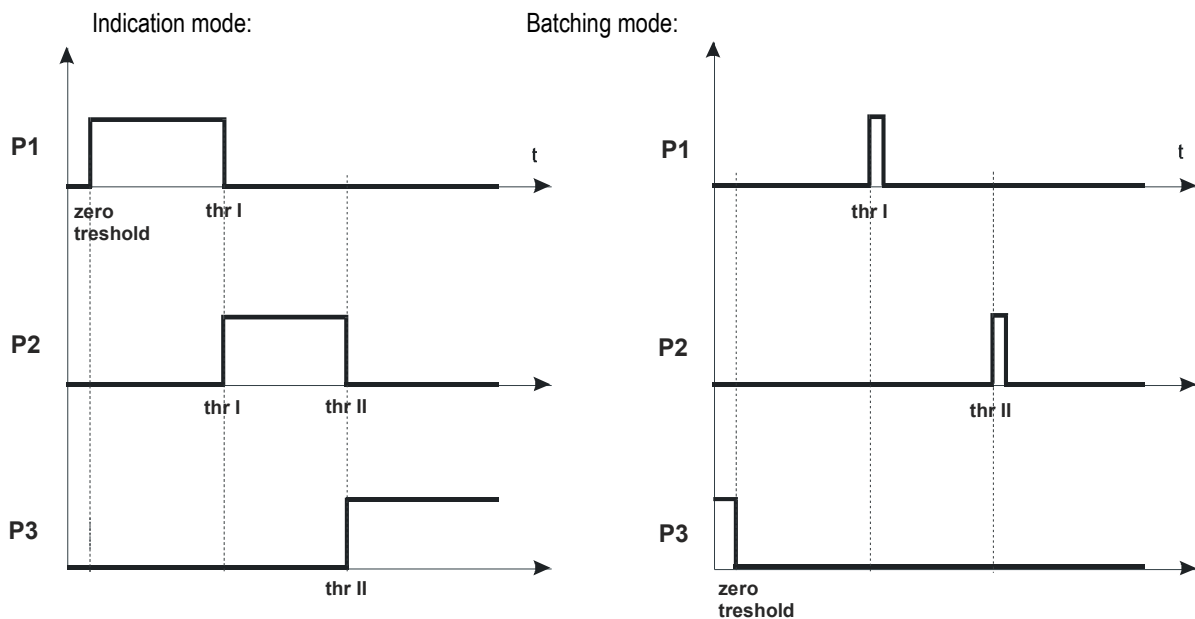

In *Batching mode* on P1 (thr I) and P2 (thr II) outputs short-circuit impulses appears for time of 0,5s. On P3 (zero) output short-circuit state appears when indication does not exceed threshold value signalling zero load.

Operation sequence:

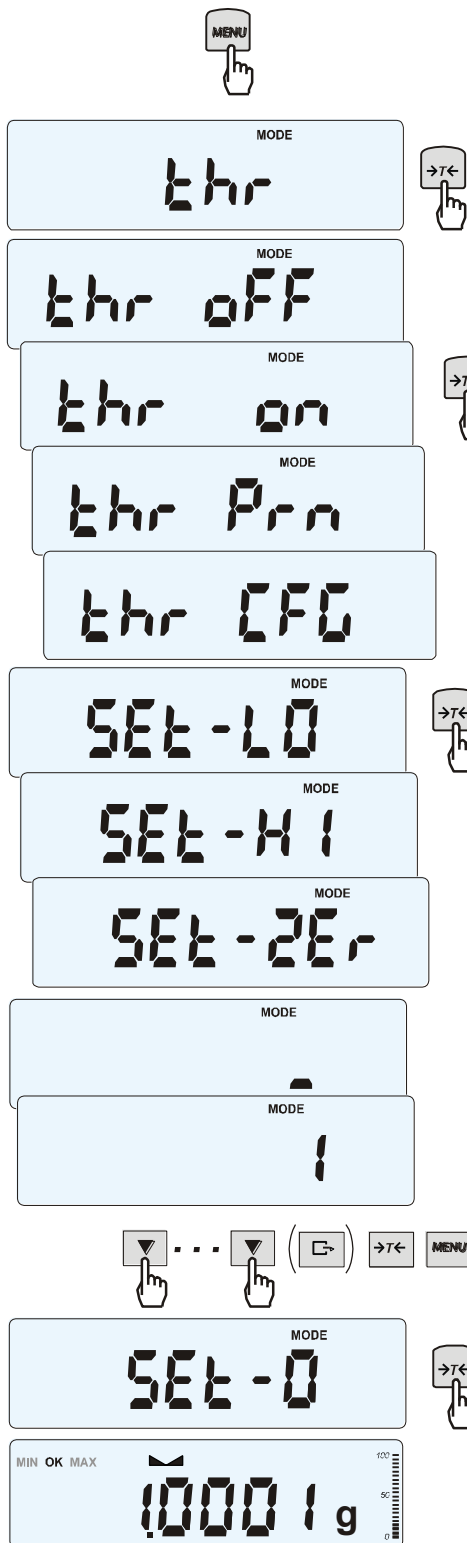

Press *MENU* key and choose *thr* pressing $\rightarrow T \leftarrow$ key.

The following options are displayed successively:

- *thr OFF* – deactivate the function,
- *thr on* – activate the function,
- *thr Prn* – check last threshold values (press $\rightarrow \leftarrow$ key several times),
- *thr CFG* – choose *Relays* socket mode:
IMPULS - *Batching* mode
SIGNAL – *Indication* mode.

Choose *thr-on* option using $\rightarrow T \leftarrow$ key. The following options for entering thresholds are displayed:

- *SEt-LO* - set lower threshold value,
- *SEt-HI* - set upper threshold value,
- *SEt-ZEr* - set zero signalisation threshold.

Using $\rightarrow T \leftarrow$ key select *SEt-LO* option.

Set lower threshold value using the following keys:

- \blacktriangledown - digit increase,
- $\rightarrow \leftarrow$ - decimal point,
- $\rightarrow T \leftarrow$ - move to next digit,
- MENU* - finish.

Then select *SEt-HI* option and enter upper threshold value.

Choosing *out* option will cause starting work with signalisation of exceeding thresholds and zero.

To change *Relays* socket mode use *thr CFG* option. Default option is *Indication*.

To leave the function, press *MENU* key and then choose *thr* and *thr OFF* options.

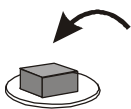

Relays connection diagram:

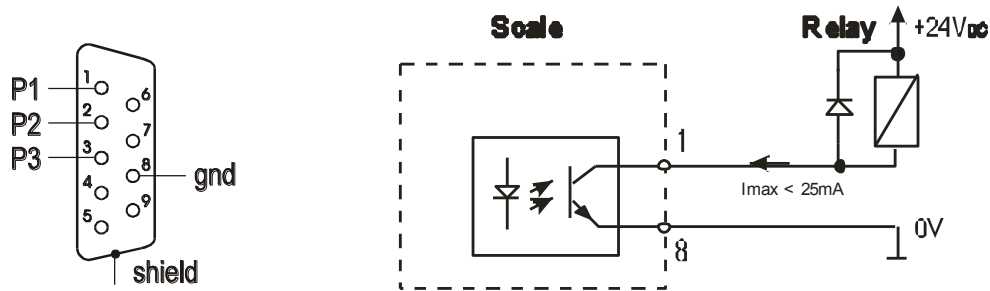

Relays output is the open collector transistor output with load capacity 25mA / 24V. Transmitter inputs must be protected with diodes, e.g. 1N4148.

It is advised to use MS3K/P electronic board (sold separately), consisting of RM96P transmitters, with DC24V input voltage and AC250V, 3A output.

Important notes:

1. After switching the scale on, both thresholds are set to maximum values.
2. When setting upper threshold value, pay attention that its value is not below lower threshold value.
3. Setting lower and upper threshold value is possible after sending appropriate orders from computer, what is described in scale user manual.

18.10 Setting date and time function (dAtE)

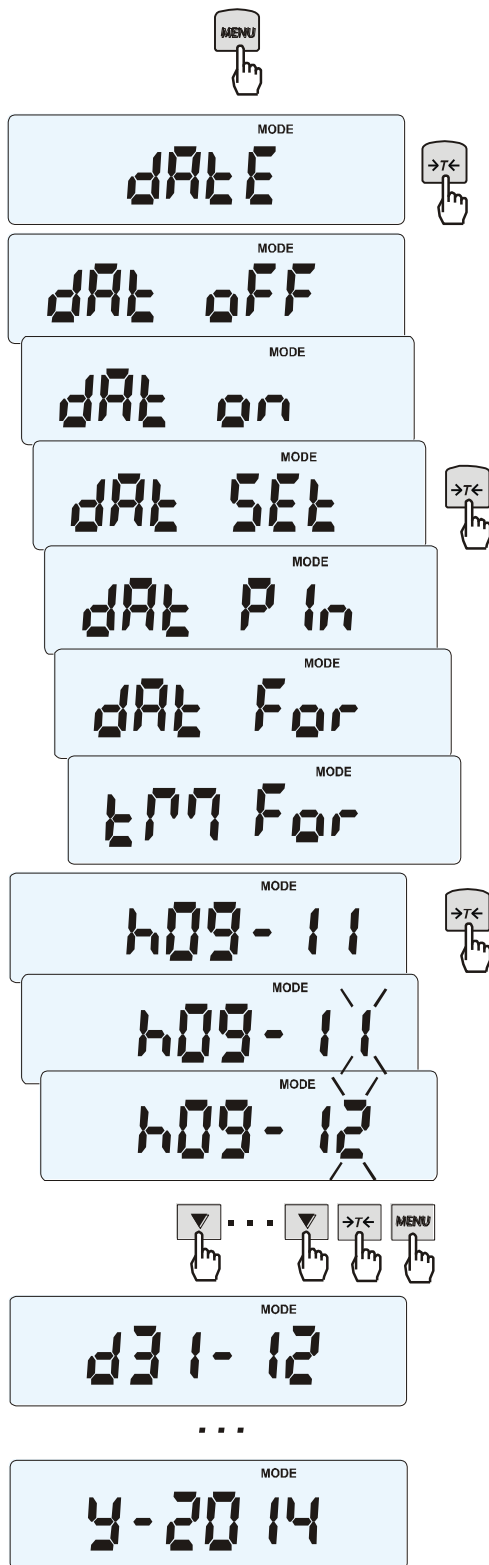

The function allows setting current date and time of scale internal clock and mode of its use.

The function has the following options:

- *dAt OFF* – deactivate date and time during printout of current weighing result,
- *dAt on* – activate date and time during printout of current indication ( key),
- *dAt SEt* - change current date and time,
- *dAt PIn* – data and time secure password (to prevent from changing date and time by unauthorized personel),
- *dAt For* – data printout in *USA* or *EU* format
- *tM For* – time printout in 24h or 12h format.

The example at the left presents how to set current date and time using *dAt SEt* option.

After setting proper date and time activate it with *dAt on* option.

UE: rrrr-mm-dd gg:mm

USA: mm-dd-rrrr gg:mm AM/PM

(*gg* – hours, *mm* – minutes, *AM* – before noon, *PM* – after noon, *mm* - month, *dd* - day, *rrrr* - year).

Attention: Inscribing non-zero *PIN* value causes showing *PIN* sign during next date and time changing and inscribing 4 digit code is necessary. (using keys $\rightarrow 0 \leftarrow$, $\rightarrow T \leftarrow$ and *MENU*).

18.11 Statistical calculations function (StAt)

This function evaluates from series of measurements (max 1000) statistical parameters of weighting process.

Adding successively measurements to register is automatic and it occur after the scale is loaded and its indications stabilize.

After each loading printout is made with: number of measurements, result, date and time (if clock is installed and the function is activated).

For the obtained measurements series the scale evaluates:

- n -number of samples
- sum x -sum of all samples $sum_x = \sum x_n$
- \bar{x} -average value (sum x)/n
- min -minimal value from n samples
- max -maximal value from n samples
- max-min -maximal value minus minima value

- S -standard deviation $S = \sqrt{\frac{1}{(n-1)} \sum_n (x_n - \bar{x})^2}$
- srel -variance factor $srel = \frac{S}{x}$

Statistical calculations results can be printed.

Order of operations:

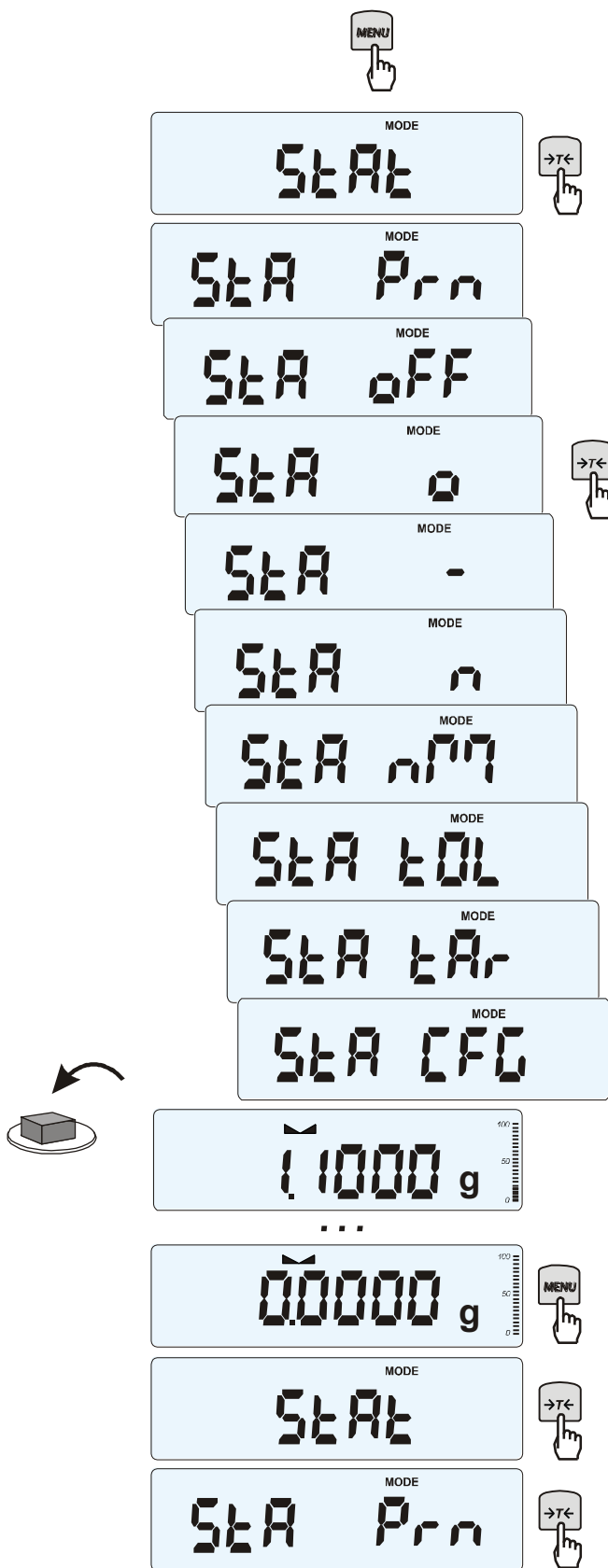

Press MENU key.

When StAt is displayed press →T← key.

The following options are displayed:

- StA Prn – monitoring and printout of statistical data,
- StA oFF – deactivate function,
- StA □ – activate function, work with printout of chosen weighting results,
- StA -- activate function, work without printout,
- StA n – maximal samples value,
- StA nM – inscribing nominal value for statistics,
- StA tOL – inscribing tolerance in %,
- StA tAr – automatic tare on/off
- StA CF0 – function configuration:
 - Auto – Automatic work (samples are confirmed after loading the scale and indication stabilization.),
 - ManuAL – manual work (confirmation is made by pressing key).
- out – exit from function.

Remember first to inscribe nominal weight value and tolerance (mentioned above).

After that, push →T← key when StA o is displayed.

Put on successive objects on the pan (remove after indication stabilization) in order to add them to measurements register.

In order to obtain printed statistical results from measurements series press MENU key and →T← key when StAt is displayed and later StA Prn.

After printout two options are enabled:

- rESET – erasing results,
- Contin – continuation.

Pressing  key printouts estimated values and histogram :

Nominal - nominal value,

Tolerance - accepted value in percentage.

N - number of sample

IN TOL. – number of samples in toleranc

-TOL – amount of measurements

under allowable lower value

+TOL – amount of measurements above

allowable upper value

TOTAL - sum of weights of all n samples

AVERAGE – average weight as (Total)/n

MIN – minimum weight in n samples

MAX– maximum weight in n samples

ST. DEV. – standard deviation

ST. DEV.% – standard deviation percentage

To finish work with this function and

zeroing result register press MENU

key and then when StAt. and Sta OFF is

displayed press →T← button.

Statistics function cooperation with computer and Printer. Scale can be equipped with two serial ports marked as RS232C-I (computer) and RS232C-II (printer). After each data printout by printer identical set of data is sent to computer. After sending by computer initialization signal S A CR LF (53h 49h 0Dh 0Ah) the scale sends to computer statistic data enclosed in histogram.

----- STATISTICS -----				
NOMINAL :	50.000 g			
TOLERANCE:	100 %			
MAX. N :	500			
NO.	SAMPLE	TOL-	NOM	TOL+
1	10.007 g	:	*	:
2	20.125 g	:	*	:
3	20.126 g	:	*	:
4	30.205 g	:	*	:
5	30.204 g	:	*	:
6	30.201 g	:	*	:
7	40.557 g	:	*	:
...				
N :	25			
IN TOL. :	25			
< TOL-	0			
> TOL+	0			
TOTAL :	1264.664 g			
AVERAGE :	50.587 g			
MAX :	91.131 g			
MIN :	10.007 g			
MAX-MIN :	81.124 g			
ST.DEV. :	20.6480 g			
ST.DEV.% :	40.82 %			
----- HISTOGRAM -----				
<TOL-	0 I			
	0 I			
	1 I			
	2 I			
	3 I			
	4 I			
	5 I			
	4 I			
	3 I			
	2 I			
	0 I			
	1 I			
>TOL+	0 I			

18.13 Density determination (dEnSItY)



NET
0.0000 g

MODE
dEnS ItY

MODE
dEn off

MODE
dEn on

MODE
SOL Id

MODE
L 190 Id

MODE
H2O

MODE
EthAnOL

MODE
t °C

MODE
20.0

MODE
!

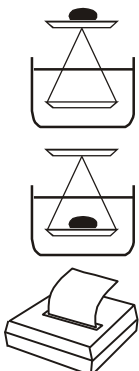

80.000 g

70.000 g

20.00 g

Solids density determination

This function calculates material density basing on its weight in air and in water using the formula below:

$$\rho = \frac{m_1}{m_1 - m_2} * \rho_L$$

where, m_1 – weigh in air
 m_2 – weight in water
 ρ_L – density of liquid

If distilled water (H_2O) or ethanol (*EthAnOL*) is used, enter its exact temperature (accurate to 0,5°C) – the balance will calculate its density automatically.

To enter the value use the following keys:

- ▼ - digit increase,
- ↵ - decimal point,
- T← - next digit,
- MENU - end.

When using liquid other than distilled water or ethanol, choose OTHER option and enter its density according to its temperature.

Phase I: measurement in air.
 Phase II: measurement in liquid.

To print measurement result and begin next measurement press ↵ key.

To print a density determination report after all necessary measurements, connect a printer to the balance and press  key. A sample for solid mass density determination is shown below:

-----DENSITY-----	
Mass in the air	= ...
Mass in the liquid	= ... g
Mass density	= ... g/cm ³
Density with comp.	= ... g/cm ³
Water density	= ... g/cm ³
Water temperature	= ... °C

Operation sequence (weighing in air and in liquid) for below-balance weighing:

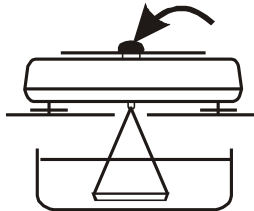

Phase I: measurement in air.

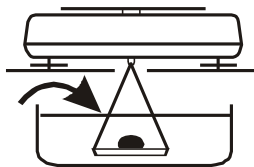

Phase II: measurement in liquid.

Liquid density determination

This function determines liquid density basing on plunger weight in air and in examined liquid with known volume, using the formula below:

$$\rho = \frac{m_1 - m_2}{V}$$

where
 m₁ – plunger weight in air
 m₂ – plunger weight in a liquid
 V – plunger volume

Plunger volume is stored on its hanger.

To enter the value use the following keys:

- ▼ - digit increase,
- ⇐ - decimal point,
- T← - next digit,
- MENU - end.

Phase I: measurement in air.

Phase II: measurement in liquid.

To print measurement result and begin next measurement press ⇐ key.

The sequence of screens is as follows:

- NET 0.0000 g
- MODE dEnS itY
- MODE dEn OFF
- MODE dEn ON
- MODE SOL Id
- MODE L IQU Id
- MODE PLUNGER
- MODE VOLUME
- MODE 2.0
- MODE 1
- MODE 8.000
- MODE 6.000
- MODE 1.0000

19. Troubleshooting and maintenance

1. The balance should be kept clean.
2. Take care that no dirt is between the casing and the pan. If a dirt is noticed, take off the pan (lift it up), clean a dirt and then mount the pan.
3. In case of improper operation caused by a short-lasting lack of power supply, switch the balance off by unplugging it from the mains, and then after several seconds switch it on.
4. All repairs of the balance should be performed by authorised service centre.
5. To repair a balance, please contact nearest service centre. The list of authorised service centres is given in guarantee card.
6. Balances can be sent for repair as messenger delivery only in original package, if not, there is a risk of damaging the balance and losing guarantee.

Failure messages:

Message	Possible cause	Recommendation
<i>C-1 ... 6</i> (more than 1 min.)	negative result in one of autotests	if message still remains, contact service centre
<i>L</i>	no pan on the balance	put the pan on
	mechanical damage	contact service centre
<i>H</i>	overweight of the balance	take a load off the pan
	mechanical damage	contact service centre
<i>Err-H</i>	load left on the pan	take a load off the pan
 indicator does not work	unstable balance position, ground vibration, air flows	locate the balance in place where stable results are maintained
	damage of the balance	contact service centre
-----	taring not finished	contact service centre
<i>Pr-on</i>	Calibration switch is in ON position or switch is damaged	Change switch position into OFF or contact authorised service